

V-Raising and Grammar Competition in Korean: Evidence from Negation and Quantifier Scope

Chung-hye Han
Jeffrey Lidz
Julien Musolino

In a head-final language, V-raising is hard to detect since there is no evidence from the string to support a raising analysis. If the language has a cliticlike negation that associates with the verb in syntax, then scope facts concerning negation and a quantified object NP could provide evidence regarding the height of the verb. Even so, such facts are rare, especially in the input to children, and so we might expect that not all speakers exposed to a head-final language acquire the same grammar as far as V-raising is concerned. Here, we present evidence supporting this expectation. Using experimental data concerning the scope of quantified NPs and negation in Korean, elicited from both adults and 4-year-old children, we show that there are two populations of Korean speakers: one with V-raising and one without.

Keywords: V-raising, negation, quantifier, scope, grammar competition, poverty of the stimulus, head-final language, Korean

1 Introduction

The argument from the poverty of the stimulus has maintained a central place in the development of generative grammar at least since Chomsky 1965. The argument runs like this. There is a piece of grammatical knowledge *G* that can be attributed to adult speakers of a language. Examination of the input to the child shows that the ambient language (i.e., the language of the community that the learner is exposed to) does not uniquely determine *G*. That is, the primary linguistic data that the child is exposed to are compatible with a range of hypotheses that includes (but does not require) *G*. Given that adults know *G* and that *G* represents only one point in a range of hypotheses compatible with experience, it follows that *G* must be determined innately. In other words, all

Previous versions of this article have been presented at the 38th regional meeting of the Chicago Linguistic Society; the 13th Japanese/Korean Linguistics Conference; the Linguistic Society of America workshop ‘‘UG Principles and Input Data’’ at the University of Michigan, East Lansing, in 2003; the University of Calgary linguistics colloquium in 2003; the University of British Columbia linguistics colloquium in 2004; and the workshop ‘‘Construction of Meaning’’ at Stanford University in 2005. We have benefited at various stages from the critical comments and questions of the audiences at these presentations. We also thank the two anonymous *LI* reviewers for their helpful comments, and Mee-Sook Kim for assistance with stimulus design and data collection in the initial stage of the research reported here. Our work was supported in part by SSHRC Standard Research Grant 410-2003-0544 to Han and NSF grant BCS-0418309 to Lidz.

of the other hypotheses compatible with the primary linguistic data are excluded a priori. Learners acquire G because it is the unique point of intersection between the primary linguistic data and the innate hypothesis space. In this article, we present a novel consequence of the poverty of the stimulus. We will consider a case in which the learner's innate hypothesis space arguably provides at least two hypotheses that are compatible with the primary linguistic data. In this case, experience does not determine which of these is the correct grammar. Consequently, some learners acquire one grammar and others acquire the other. In short, even given a restricted and innately determined hypothesis space, experience is sometimes insufficient for grammar transmission from one generation to the next.

In particular, we will examine the position of the verb in Korean. In a head-final language like Korean, V-raising is hard to detect since there is no evidence from simple SOV strings that would differentiate between a structure in which the verb occupies V and one in which it has raised to I(nflection). This is so both for children acquiring the language and for linguists developing an analysis of it. Indeed, syntacticians examining Korean have made claims in both directions, some arguing that there is no V-raising (Han and Park 1994, Yoon 1994, M.-K. Park 1998) and others arguing that V-raising does occur (Otani and Whitman 1991, Park 1992, Cho 1994, Yi 1994, Choi 1999, Koizumi 2000). As we will show, neither the evidence for a raising analysis nor the evidence for an analysis without raising is definitive. All of the data used in the argumentation in the literature have explanations consistent with either analysis.

One potential source of information that would be more instructive concerns the syntax of negation. Because Korean has a cliticlike negation that associates with the verb in syntax, scope facts concerning negation and a quantified object NP could provide evidence regarding the height of the verb. Even so, such facts are rare, especially in the input to children, and so we might expect that not all speakers exposed to a head-final language acquire the same grammar as far as V-raising is concerned. Indeed, we present evidence here supporting this expectation from Korean. Using data obtained from psycholinguistic experiments, we show that there are two populations of Korean speakers: one with V-raising and one without.

This article is organized as follows. In section 2, we review the kind of evidence used in the linguistic literature to determine whether Korean exhibits V-raising. We consider evidence from null object constructions (section 2.1), scrambling and coordination (section 2.2), negative polarity item licensing (section 2.3), and coordination of an untensed conjunct with a tensed one (section 2.4). We show that in all these cases, no firm conclusions can be drawn regarding the availability of V-raising in Korean, as all the data claimed to support a V-movement analysis are compatible with a non-V-movement grammar and vice versa. Next, we consider evidence involving the position of the verb with respect to negation (section 3.1) and scope interactions between negation and quantified NPs (section 3.2). We show that while the evidence from scope interactions would be informative regarding the possibility of V-raising in Korean, the extant literature on this topic is plagued by contradictory conclusions, giving the impression that syntacticians studying Korean cannot agree on what the facts are (section 3.3). Since only facts involving negation and quantified NPs hold the promise of settling the issue of whether Korean is a V-raising

language, it becomes crucial that the relevant facts be determined as precisely as possible. To achieve this goal, we conducted two psycholinguistic experiments using the truth-value judgment task (Crain and Thornton 1998), a technique devised to elicit reliable interpretive judgments (sections 4.1 and 4.2). After presenting our findings in section 4, we discuss their implications regarding the availability of V-raising in Korean in section 5.

2 The Issue of V-Raising in Korean

Traditionally, differences in verb placement with respect to adverbs have been used to argue for or against V-raising to I for a given language (Emonds 1978, Pollock 1989). Consider the data in (1)–(2).

(1) *French*

- a. *Jean souvent embrasse Marie. (*S Adv V O)
 Jean often kisses Marie
 b. Jean embrasse souvent Marie. (S V Adv O)
 Jean kisses often Marie
 ‘Jean often kisses Marie.’

(2) *English*

- a. John often kisses Mary. (S Adv V O)
 b. *John kisses often Mary. (*S V Adv O)

Assuming that French and English clauses have similar hierarchical structure and that *often*-type adverbs are placed in the same position in both languages (namely, adjoined to VP), the word order in which the verb precedes the adverb is taken to be evidence for V-raising, as in French (3a), and the order in which the verb follows the adverb is taken to be evidence for I-lowering, as in English (3b).

(3) a. *French*

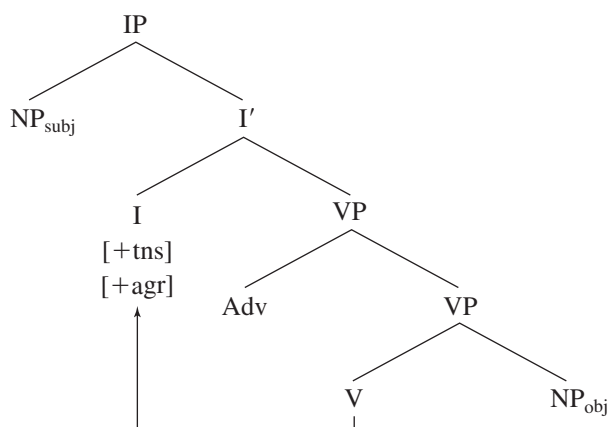

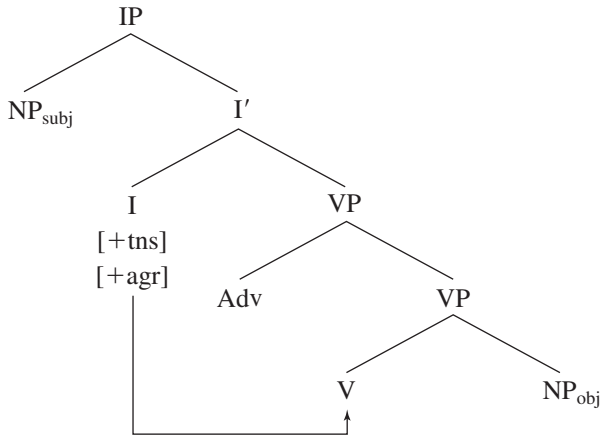
b. *English*

However, in a head-final language like Korean (4), with specifiers/adjuncts on the left of the verb as in (5), V-raising is hard to detect because there is no evidence from the string to support a raising analysis. Whether the verb raises or not, it will occur to the right of such adverbial elements.

- (4) Yuri-ka cacwu Toli-lul ttayli-n-ta.
 Yuri-NOM often Toli-ACC hit-PRES-DECL
 'Yuri often hits Toli.'

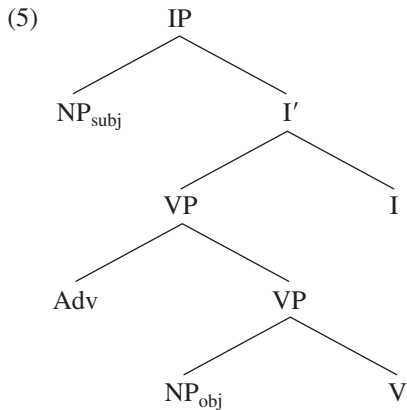

We thus need to resort to arguments other than those relying on the string order between the verb and a diagnostic element to settle the matter. In what follows, we examine such arguments claimed in the literature to demonstrate that Korean either does or does not exhibit V-raising. The arguments presented in sections 2.1 and 2.2 were originally based on facts in Japanese, and we have duplicated them here using Korean examples.

2.1 Null Object Constructions

Otani and Whitman (1991) argue that the sloppy reading in the null object construction (NOC) in Japanese (and Korean) is evidence for V-raising. They propose that through V-raising, the NOC results in an empty VP, analogous to VP-ellipsis in English, allowing a sloppy reading, just as VP-ellipsis in English does. Their argument can be duplicated using Korean examples: the Korean NOC in (6B) can have a sloppy reading, just like the English VP-ellipsis example in (7).

- (6) A: John-un caki-uy phyenci-lul pely-ess-ta.
 John-TOP self-GEN letter-ACC discard-PST-DECL
 ‘John threw away self’s letter.’
 B: Mary-to [e] pely-ess-ta.
 Mary-also discard-PST-DECL
 ‘Mary_j also threw out self_j’s letters.’ (sloppy reading)
 ‘Mary also threw out John’s letters.’ (strict reading)

(7) John threw away his letter; Mary did [_{VP} e] too.

Hoji (1998), however, shows that the sloppylike readings in the NOC are not the genuine sloppy reading attested in VP-ellipsis constructions. While English VP-ellipsis examples generally have sloppy readings available, the corresponding Japanese NOCs do not always do so. This point applies to Korean NOCs as well, as illustrated in (8)–(9).

- (8) A: John consoled himself.
 B: Bill did too. (✓strict reading, ✓sloppy reading)
- (9) A: John-un cakicasin-ul wylohayecwu-ess-ta.
 John-TOP self-ACC console-PST-DECL
 ‘John consoled himself.’
 B: Bill-to [e] wylohayecwu-ess-ta.
 Bill-also console-PST-DECL
 ‘Bill consoled [e] too.’ (✓strict reading, *sloppy reading)

According to Hoji, sloppylike readings in NOCs arise because of the way the content of the null argument is recovered from discourse. The null argument can be either a definite or an indefinite. Applying this to Korean, in (6), the null argument corresponds to indefinite ‘letters’, which can be interpreted as John’s letters (corresponding to a strict reading) or Mary’s letters (corresponding to a sloppy reading). In (9), the null argument is definite and refers to *John*, the most salient entity in the discourse, allowing only the strict reading. If Hoji is correct, NOC examples with sloppylike readings have no bearing on the issue of V-raising.

Kim (1999) also provides several arguments that show that the readings in NOCs could not be evidence for overt V-raising in Korean. Here, we briefly discuss one of his arguments. Kim provides an example of an NOC without VP-ellipsis that nevertheless has a sloppy reading. (10A) is an example of a multiple accusative construction conveying a part-whole relationship, where

the first accusative-marked NP refers to the whole and the second accusative-marked NP refers to the part. In (10B), the part-NP remains within VP.¹ But even though no VP-ellipsis site is available, (10B) can have a sloppy reading.

- (10) A: Jerry-nun caki-uy ai-lul phal-ul ttayli-ess-ta.
 Jerry-TOP self-GEN child-ACC arm-ACC hit-PST-DECL
 ‘Jerry hit his child on the arm.’
 B: Kulena Sally-nun [e] tali-lul ttayli-ess-ta.
 but Sally-TOP leg-ACC hit-PST-DECL
 ‘But Sally hit [e] on the leg.’ (✓strict reading, ✓sloppy reading)

This fact then suggests that a strategy other than VP-ellipsis is responsible for the sloppy reading in Korean NOCs, and so they cannot have any bearing on the issue of V-raising.

2.2 Scrambling and Coordination

Using examples from coordination and scrambling, and making the reasonable assumption that coordinate structures conjoin syntactic constituents of like categories, Koizumi (2000) argues that the verb raises all the way up to C(omp) in Japanese (and in Korean). If we apply Koizumi’s arguments to Korean examples, then ‘‘Subject [Object and Object] Verb’’ coordinate structures are derived through coordination of subclauses (represented as FPs below), with across-the-board (ATB) V-raising at least to I. This is illustrated in (11). Moreover, ‘‘[Subject Object] and [Subject Object] Verb’’ coordinate structures are derived through IP-coordination, with ATB V-raising to C, as illustrated in (12). Crucially, the coordinate structures (FP and IP in (11)–(12)) can be scrambled, supporting the claim that they form constituents.

- (11) Mary-ka [[_{FP} motun sakwa-lul t_i] kuliko [_{FP} motun panana-lul t_i]] mek_i-ess-ta.
 Mary-NOM every apple-ACC and every banana-ACC eat-PST-DECL
 ‘Mary ate every apple and every banana.’
 (12) [[_{IP} Mary-ka motun sakwa-lul t_i] kuliko [_{IP} Nancy-ka motun panana-lul t_i]]
 Mary-NOM every apple-ACC and Nancy-NOM every banana-ACC
 mek_i-ess-ta.
 eat-PST-DECL
 ‘Mary ate every apple and Nancy ate every banana.’

¹ One might say that an empty VP can still be made in (10B) by scrambling the part-NP out of the VP over the empty whole-NP, and raising the verb. But as Kim (1999) notes, this cannot be a possible derivation because the part-NP must be c-commanded by the whole-NP, as shown by the ungrammaticality of (i).

- (i) *Kulena Sally-nun tali-lul_i [caki-uy ai-lul] t_i ttayli-ess-ta.
 but Sally-TOP leg-ACC self-GEN child-ACC hit-PST-DECL
 ‘But Sally hit her child on the leg.’

However, similar examples can be constructed where the material shared by the two conjuncts contains more than just the verb, as in (13)–(14). This means that the ATB extraposition can target not only verbs but also bigger constituents, making the kind of example Koizumi provides a subcase of a more general phenomenon, not relevant to the issue of V-raising.²

- (13) Mary-ka [[_{FP} motun sakwa-lul t_i] kuliko [_{FP} motun panana-lul t_i]] *culkepkey*
 Mary-NOM every apple-ACC and every banana-ACC joyfully
mek_i-ess-ta.
 eat-PST-DECL
 ‘Mary ate every apple and every banana joyfully.’

- (14) [[_{IP} Mary-ka motun sakwa-lul t_i] kuliko [_{IP} Nancy-ka motun panana-lul t_i]]
 Mary-NOM every apple-ACC and Nancy-NOM every banana-ACC
culkepkey mek_i-ess-ta.
 joyfully eat-PST-DECL
 ‘Mary ate every apple and Nancy ate every banana joyfully.’

Fukui and Sakai (2003) provide several arguments against Koizumi’s string-vacuous V-raising in Japanese. Here, we present one argument that is most pertinent to Korean, duplicating the argument using Korean examples.³ The coordinate particle *kuliko* ‘and’ can conjoin elements

² A reviewer suggests that the examples in (13)–(14) could still be taken as evidence for V-raising if one can argue that the adverb has undergone a different kind of rightward movement (something like scrambling) separate from the putative ATB V-raising. Here, we present an example with apparent ATB extraposition of a main verb and an auxiliary verb. In this case, one cannot argue that the main verb has undergone a separate scramblinglike movement. So our point that the extraposed material can contain more than just the verb receives further support.

- (i) Mary-ka [[_{FP} motun sakwa-lul t_i] kuliko [_{FP} motun panana-lul t_i]] *meke pely_i-ess-ta.*
 Mary-NOM every apple-ACC and every banana-ACC eat throw-PST-DECL
 ‘Mary ate up every apple and every banana.’
- (ii) [[_{IP} Mary-ka motun sakwa-lul t_i] kuliko [_{IP} Nancy-ka motun panana-lul t_i]] *meke pely_i-ess-ta.*
 Mary-NOM every apple-ACC and Nancy-NOM every banana-ACC eat throw-PST-DECL
 ‘Mary ate up every apple and Nancy ate up every banana.’

We note that the derivation of all these examples with apparent ATB extraposition may not involve a rightward syntactic movement of the material in the ATB extraposed position. Chung (2004) has shown that plurality-dependent expressions such as plural-marked adverbs are licensed in an ATB extraposed position, as in (iii), although the same expressions cannot be licensed in each conjunct, as in (iv).

- (iii) John-un nonmwun-ul kuliko Mary-nun chayk-ul yelsimhi-*tul* ilk-ess-ta.
 John-TOP article-ACC and Mary-TOP book-ACC hard-PL read-PST-DECL
 ‘John read the article hard and Mary read the book hard.’
- (iv) John-un nonmwun-ul yelsimhi(*-*tul*) ilk-ess-ko Mary-nun chayk-ul yelsimhi(*-*tul*) ilk-ess-ta.
 John-TOP article-ACC hard-PL read-PST-CONJ Mary-TOP book-ACC hard-PL read-PST-DECL
 ‘John read the article hard and Mary read the book hard.’

The contrast between (iii) and (iv) shows that the two examples cannot be derivationally related and poses a serious problem in general for the rightward ATB raising analysis of the examples discussed in section 2.2.

³ See Fukui and Sakai 2003 for a detailed critique of Koizumi’s (2000) arguments against string-vacuous V-raising in Japanese.

that do not appear to be syntactic constituents. For example, in (15), the first conjunct contains *Suni-eykey* ‘Suni-to’, an argument of the matrix verb *pwuthakha-yess-ta* ‘request-PST-DECL’, and *sakwa-lul* ‘apple-ACC’, an argument of the embedded verb *kacyeo-lako* ‘bring-COMP’. These two elements could not form a constituent, even if the embedded verb were to raise to the embedded I string-vacuously. Furthermore, the fact that adverbs can freely occur between the embedded and matrix verbs indicates that the constituency cannot be obtained by moving the embedded verb to the matrix I.

- (15) Juni-nun [Suni-eykey sakwa-lul] kuliko [Toli-eykey panana-lul] kacyeo-lako
 Juni-TOP Suni-to apple-ACC and Toli-to banana-ACC bring-COMP
 kancellhi pwuthakha-yess-ta.
 sincerely request-PST-DECL
 ‘Juni sincerely asked Suni to bring apples and Toli to bring bananas.’

In short, no matter what the correct analysis of such a coordinate structure may be, V-raising to I cannot be the answer. Given this, Koizumi’s argument for V-raising based on coordinate structures dramatically weakens.

2.3 Negative Polarity Item Licensing

In a negative sentence, regardless of the type of negation it contains, a negative polarity item (NPI) can appear in both subject and object positions in Korean, as in (16)–(17). Descriptively, NPIs are possible as long as there is a licenser (negation) in the same clause (Clausemate Condition; Choe 1988).

- (16) a. John-un amwukesto an mek-ess-ta.
 John-TOP anything NEG eat-PST-DECL
 ‘John didn’t eat anything.’
 b. John-un amwukesto mek-ci ani ha-yess-ta.
 John-TOP anything eat-CI NEG do-PST-DECL
 ‘John didn’t eat anything.’
- (17) a. Amwuto khwukhi-lul an mek-ess-ta.
 anyone cookie-ACC NEG eat-PST-DECL
 ‘Nobody ate the cookies.’
 b. Amwuto khwukhi-lul mek-ci ani ha-yess-ta.
 anyone cookie-ACC eat-CI NEG do-PST-DECL
 ‘Nobody ate the cookies.’

Choi (1999) takes this as evidence for V-raising. Assuming that negation is a clitic on the verb, he argues that NPIs in both subject and object positions are licensed because they are in the scope of negation once the verb moves up along with the cliticized negation.

But it can be shown that scope of negation and NPI-licensing domain do not always go

together. First, as we will illustrate in section 3.3, Korean speakers do not agree on judgments concerning scope of negation and argument QPs, but there is no disagreement about the status of sentences like (16) and (17). Second, in sentences with inherently negative predicates, NPIs are licensed in subject position even though the negative predicate does not take scope over it, as Chung and Park (1997) show with examples like (18a–b).

- (18) a. Motun mwulken-i chayksang wi-ey eps-ta.
 every thing-NOM desk top-at not.exist-DECL
 ‘None of the things are on the desk.’ (✓every>neg, *neg>every)
- b. Amwukesto chayksang wi-ey eps-ta.
 anything desk top-at not.exist-DECL
 ‘Nothing is on the desk.’

Third, Chung and Park show that some NPIs in Korean cannot be in the scope of negation, even though they require a clausemate negation to be licensed. Such an NPI is *celtaylo* ‘absolutely’. The example in (19a) is not well formed because there is no licensing negation in the same clause as *celtaylo*. The examples in (19b–c) are well formed because there is a licensing negation in the same clause as *celtaylo*, but they both have the interpretation in which *celtaylo* takes scope over the licensing negation.

- (19) a. *Ku-nun celtaylo kukos-ey ka-ss-ta.
 he-TOP absolutely there-to go-PST-DECL
 ‘He absolutely went there.’
- b. Ku-nun celtaylo kukos-ey ka-ci ani ha-yess-ta.
 he-TOP absolutely there-to go-CI NEG do-PST-DECL
 ‘It is absolutely true that he did not go there.’
 ‘*It is not the case that he absolutely went there.’
- c. Ku-nun celtaylo kukos-ey an ka-ss-ta.
 he-TOP absolutely there-to NEG go-PST-DECL
 ‘It is absolutely true that he did not go there.’
 ‘*It is not the case that he absolutely went there.’

All these facts show that NPI-licensing in Korean does not coincide with scope of negation, and so it has no bearing on the issue of V-raising.

2.4 Coordination of an Untensed Conjunct with a Tensed Conjunct

An argument against V-raising is provided by Yoon (1994). He argues that inflectional suffixes in Korean are syntactically independent and combine with roots not by V-raising, but by what he calls “phrasal affixation”: that is, inflections cliticize to phrases for which they subcategorize in morphology. His argument is based on coordinate structures conjoining an untensed clause and a tensed clause. He proposes that when tense is specified only on the verb in the last conjunct,

the coordinate structure instantiates VP-level conjunction as in (20), whereas when tense is specified in all the conjuncts, IP-level coordination is involved as in (21). If Yoon's proposed structure for untensed conjuncts is correct, then the verb in the final tensed conjunct cannot be combining with inflections through V-raising. This is so because V-raising would violate the Coordinate Structure Constraint. The only possibility then is that the inflections lower onto appropriate places in morphology.

- (20) a. John-i [[_{VP} pap-ul mek-ko] [_{VP} kulus-ul chiwu]]-ess-ta.
 John-NOM meal-ACC eat-CONJ dishes-ACC clean-PST-DECL
 'John ate the meal and cleaned the dishes.'
- b. [[_{VP} John-i pap-ul mek-ko] [_{VP} Mary-ka kulus-ul chiwu]]-ess-ta.
 John-NOM meal-ACC eat-CONJ Mary-NOM dishes-ACC clean-PST-DECL
 'John ate the meal and Mary cleaned the dishes.'
- (21) a. [[_{IP} John-i pap-ul mek-ess-ko] [_{IP} pro kulus-ul chiwu-ess]]-ta.
 John-NOM meal-ACC eat-PST-CONJ dishes-ACC clean-PST-DECL
 'John ate the meal and cleaned the dishes.'
- b. [[_{IP} John-i pap-ul mek-ess-ko] [_{IP} Mary-ka kulus-ul chiwu-ess]]-ta.
 John-NOM meal-ACC eat-PST-CONJ Mary-NOM dishes-ACC clean-PST-DECL
 'John ate the meal and Mary cleaned the dishes.'

Yoon provides three arguments for his proposed coordinate structures. First, noting that NPIs in Korean are possible in both subject and object positions licensed by a clausemate negation, Yoon argues that *amwuto* 'anyone' is licensed in (22a) with VP-level coordination because it is in the same clause as negation *ani*. But in (22b), with IP-level coordination, *amwuto* is not licensed because it is not in the same clause as *ani*.

- (22) a. Amwuto [[_{VP} pap-ul mek-ko] [_{VP} kulus-ul chiwu-ci]] ani ha-yess-ta.
 anyone meal-ACC eat-CONJ dishes-ACC clean-CI NEG do-PST-DECL
 'No one ate the meal and cleaned the dishes.'
- b. *[[_{IP} Amwuto pap-ul mek-ess-ko] [_{IP} kulus-ul chiwu-ci ani ha-yess]]-ta.
 anyone meal-ACC eat-PST-CONJ dishes-ACC clean-CI NEG do-PST-DECL
 'No one ate the meal and cleaned the dishes.'

Second, in (23a), scrambling of *pap-ul* 'meal-ACC' is fine even though this violates the Coordinate Structure Constraint. Yoon says that *pap-ul* can be scrambled because it adjoins to VP, and from there it properly binds its trace, in the sense of Saito's (1985) Proper Binding Condition. In contrast, in (23b), scrambling of *pap-ul* is ruled out because it has moved into the first clausal conjunct, and from there it cannot properly bind its trace in the second clausal conjunct.

- (23) a. John-i pap-ul_i [[_{VP} chayk-ul ilk-ko] [_{VP} t_i mek]]-ess-ta.
 John-NOM meal-ACC book-ACC read-CONJ eat-PST-DECL
 'John read the book and ate the meal.'

- b. * $[[_{IP} \text{John-i} \quad \text{pap-ul}_i \quad \text{chayk-ul} \quad \text{ilk-ess-ko}] \quad [_{IP} \text{pro } t_i \text{ mek-ess}]]\text{-ta.}$
 John-NOM meal-ACC book-ACC read-PST-CONJ eat-PST-DECL
 ‘John read the book and ate the meal.’

Third, when the initial conjunct is untensed, negation at the end of the sentence may negate the initial conjunct as well as the final conjunct, but when tense is specified on the initial conjunct, only the second conjunct can be negated. According to Yoon, this contrast follows because *ani* takes scope over both conjuncts in the first case, as in (24a), but in the second case it takes scope only over the second conjunct, as in (24b).

- (24) a. $[\text{John-i} \quad [_{VP} \text{pap-ul} \quad \text{mek-ko}] \quad [_{VP} \text{kulus-ul} \quad \text{chiwu-ci}]] \text{ ani ha-yess-ta.}$
 John-NOM meal-ACC eat-CONJ dishes-ACC clean-CI NEG do-PST-DECL
 ‘John didn’t eat the meal and clean the dishes.’
 ‘John ate the meal but didn’t clean the dishes.’
- b. $[[_{IP} \text{John-i} \quad \text{pap-ul} \quad \text{mek-ess-ko}] \quad [_{IP} \text{kulus-ul} \quad \text{chiwu-ci} \text{ ani ha-yess}]]\text{-ta.}$
 John-NOM meal-ACC eat-PST-CONJ dishes-ACC clean-CI NEG do-PST-DECL
 ‘John ate the meal but he didn’t clean the dishes.’

Kim (1995) demonstrates, however, that while coordination of two tensed clauses is a real case of coordination, coordination of an untensed conjunct with a tensed one is a case of clausal adjunction. To begin, Yoon predicts (25) to be grammatical because for him, the coordinated conjuncts are VPs and *ani* is in the same clause as *amwuto* ‘anyone’. According to Kim, however, *amwuto pap-ul mek-ko* ‘anyone meal-ACC eat-CONJ’ is an adjunct clause, and since it contains no clausemate negation, the NPI is not licensed.

- (25) * $[_{IP} \text{Amwuto pap-ul} \quad \text{mek-ko}] \text{ John-i} \quad \text{kulus-ul} \quad \text{chiwu-ci} \text{ ani ha-yess-ta.}$
 anyone meal-ACC eat-CONJ John-NOM dishes-ACC clean-CI NEG do-PST-DECL
 ‘No one ate the meal and John cleaned the dishes.’

Moreover, under the adjunction approach to untensed conjuncts, scrambling facts are accounted for without appealing to the Proper Binding Condition. Scrambling out of the tensed clause conjoined with an untensed clause is predicted to be possible because this is a case of local scrambling across an adjunct clause, as in (26)–(27).

- (26) $\text{Kulus-ul}_i \quad [_{IP} \text{John-i} \quad \text{pap-ul} \quad \text{mek-ko}] \text{ Mary-ka} \quad t_i \text{ chiwu-ess-ta.}$
 dishes-ACC John-NOM meal-ACC eat-CONJ Mary-NOM clean-PST-DECL
 ‘John ate the meal and Mary cleaned the dishes.’
- (27) $\text{John-i} \quad \text{pap-ul}_i \quad [_{IP} \text{pro} \text{ chayk-ul} \quad \text{ilk-ko}] \quad t_i \text{ mek-ess-ta.}$
 John-NOM meal-ACC book-ACC read-CONJ eat-PST-DECL
 ‘John read the book and ate the meal.’

The ambiguity concerning the scope of negation in (24) is also accounted for. Under the adjunction approach, the untensed conjunct is an IP adjunct containing a *pro* subject, as in (28). The scope

ambiguity of negation can now be seen as part of a general phenomenon having to do with the interpretation of matrix negation in complex sentences, in which the matrix clause, the embedded clause, or both clauses are negated.

- (28) John-i [IP pro pap-ul mek-ko] kulus-ul chiwu-ci ani ha-yess-ta.
 John-NOM meal-ACC eat-CONJ dishes-ACC clean-CI NEG do-PST-DECL
 ‘John didn’t eat the meal but cleaned the dishes.’
 ‘John ate the meal but didn’t clean the dishes.’
 ‘John neither ate the meal nor cleaned the dishes.’

Similar ambiguity arises in *John didn’t eat the meal because he would have to clean the dishes*, or *John didn’t eat the meal and clean the dishes*, as spelled out in (29) and (30).

- (29) John didn’t eat the meal because he would have to clean the dishes.
 ‘The reason why John didn’t eat the meal is that he would have to clean the dishes.’
 ‘The reason why John ate the meal is not that he would have to clean the dishes.’
- (30) John didn’t eat the meal and clean the dishes.
 ‘John didn’t eat the meal but cleaned the dishes.’
 ‘John ate the meal but didn’t clean the dishes.’
 ‘John neither ate the meal nor cleaned the dishes.’

With the untensed conjuncts analyzed as adjunct clauses, the verb in the tensed clause can combine with inflections through V-raising as well as I-lowering. Therefore, coordination of an untensed conjunct with a tensed one does not have any bearing on the issue of V-raising.

In sum, it turns out that all of the data used to argue for V-movement are consistent with a non-V-movement grammar and all of the data used to argue for the lack of V-movement are consistent with a V-movement grammar. Thus, none of the data that have been used to argue for or against V-movement have any bearing on the issue.

3 Evidence from the Scope of Negation

We will now consider one of the standard diagnostics for V-movement, negation placement with respect to the verb, and how it applies to Korean. After discussing the two types of negation in Korean and their syntactic status within clause structure, we will establish that scope interactions between negation and argument QPs can be used as evidence for or against V-raising.

3.1 Evidence from Negation

One of the standard types of evidence for V-raising comes from negation (Pollock 1989). In French, the word order in which the finite verb precedes negation is taken as evidence that the verb moves to I. An example and the corresponding structure are given in (31a) and (32a). In contrast, English main verbs require *do*-support with negation, as in (31b). This fact has been taken as evidence that the verb does not move to I in English; see (32b).

- (31) a. Jean (n')aime pas Marie.
 Jean likes NEG Marie
 b. John does not like Mary.

- (32) a. *French*

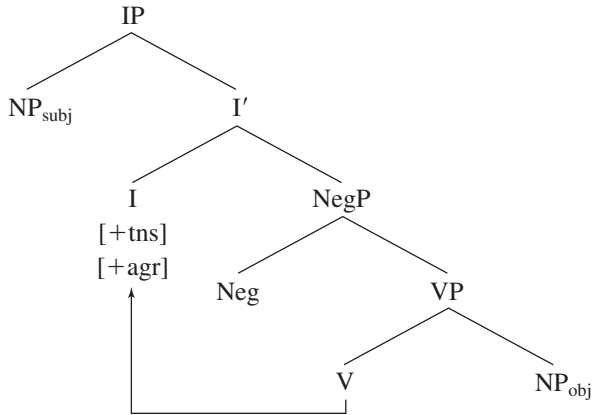

- b. *English*

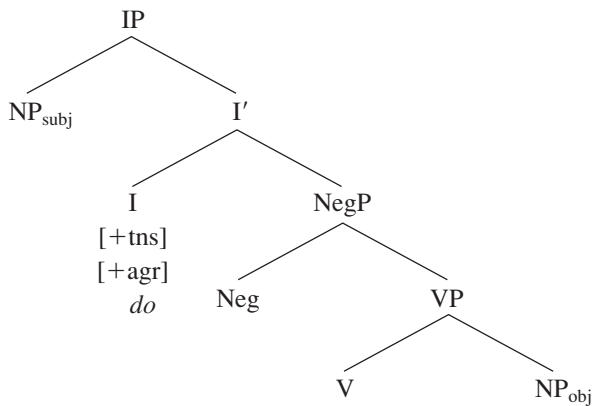

We can now ask if the position of the verb relative to negation could be informative in determining whether Korean exhibits V-raising. Korean has two forms of negation: a long form and a short form. Long negation is postverbal and requires *ha*-support (33), which is equivalent to English *do*-support. In contrast, short negation is preverbal and does not require *ha*-support (34).

- (33) *Korean long negation*

Toli-ka ttena-ci ani ha-yess-ta.
 Toli-NOM leave-CI NEG do-PST-DECL
 'Toli didn't leave.'

(34) *Korean short negation*

Toli-ka an ttena-ss-ta.

Toli-NOM NEG leave-PST-DECL

'Toli didn't leave.'

The obligatory *ha*-support in sentences with long negation indicates that long negation is a head that projects a negation phrase (NegP) and blocks V-raising. However, the existence of *ha*-support in sentences with the negative form *ani* does not tell us whether V-raising is generally blocked. For example, it is possible that verbs raise generally but fail to raise only when the head of NegP is filled. This leaves us with short negation. One possibility is that short negation has a different syntactic status from long negation, being a specifier or an adjunct, as illustrated in (35a). Alternatively, short negation might have the same syntactic status as long negation, being a head of NegP, as illustrated in (35b).

(35) a.

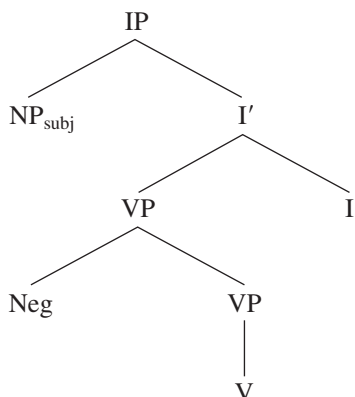

b.

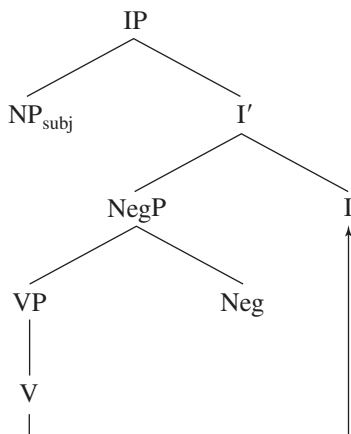

If (35a) is the correct structure, then we still do not know whether Korean exhibits V-raising. If (35b) is the correct structure, then we can conclude that Korean does exhibit V-raising, assuming

that for some reason short negation, unlike its long counterpart, does not block V-raising (or that V-raising is optional, yielding short negation if raising applies and long negation if it does not).

Unfortunately, we have reasons to believe that short negation is in a position distinct from long negation, with the representation (35a). Importantly, a sentence can contain both short and long negation, as in (36), suggesting that (35a) is the correct structure for short negation.

- (36) Toli-ka maykcwu-lul an masi-ci ani ha-yess-ta.
 Toli-NOM beer-ACC NEG drink-CI NEG do-PST-DECL
 ‘Toli didn’t not drink beer.’ (Toli drank beer)

However, even if (35a) is the right structure for short negation, we can make use of short negation to determine the height of the verb by exploring scope interactions between negation and quantified objects.

3.2 Exploring Scope Interactions between Negation and Object QPs

As evidence for using scope interactions between negation and object QPs as a diagnostic for V-raising, we present three background facts about Korean: frozen scope, object raising, and the clitic status of negation.

First, it has been widely observed that in Korean, as in Japanese, argument QPs exhibit frozen scope.⁴ That is, in a sentence like (37a) with canonical SOV word order, with subject and object QPs, the only reading available is the one in which the subject takes scope over the object. The inverse scope is possible only if the object scrambles over the subject, as in (37b) (Joo 1989, Ahn 1990, Sohn 1995, Hagstrom 2000).

⁴ A reviewer provides the example in (i), saying that it is ambiguous between the reading in which everyone loves a possibly different person and the reading in which everyone loves the same person, and that such examples therefore undermine our assumption that Korean quantifiers have the scope-freezing property.

- (i) Motwu-ka nwukwunka-lul salangha-n-ta.
 everyone-NOM someone-ACC love-PRES-DECL
 ‘Everyone loves someone.’

However, the fact that (i) seems to allow the two readings described above is not an issue of ambiguity; rather, it is an issue of vagueness. This sentence, interpreted under the logical form in which *motwu-ka* ‘everyone’ takes scope over *nwukwunka-lul* ‘someone’, is true in a situation where everyone happens to love the same person as well as in a situation where everyone loves different person. For similar discussion of vagueness using English examples, see Reinhart 1997.

The same reviewer notes that the scrambled version of (i) in (ii) is scopally ambiguous, like (i), but unlike (37a), even though in both (ii) and (37a), the string order between the quantifiers corresponding to *some* and *every* is the same.

- (ii) [Nwukwunka-lul]_i motwu-ka t_i salangha-n-ta.
 someone-ACC everyone-NOM love-PRES-DECL
 ‘Everyone loves someone.’

As noted in the text in the discussion of (37a), frozen scope is restricted to sentences with canonical order without any scrambling. The fact that (ii) is ambiguous while (37a) is not is as expected: (ii) involves scrambling, so more scopal readings are allowed; but (37a) does not involve any scrambling, so the only scopal reading available is the one provided by the surface order between the two quantifiers. We point out that none of the examples we use to test the scope of negation and object QPs (see section 4) involve any scrambling.

- (37) a. Nwukwunka-ka motun salam-ul piphanhay-ss-ta.
 someone-NOM every person-ACC criticize-PST-DECL
 ‘Someone criticized every person.’ (some>every, *every>some)
- b. [Motun salam-ul]_i nwukwunka-ka t_i piphanhay-ss-ta.
 every person-ACC someone-NOM criticize-PST-DECL
 ‘Someone criticized every person.’ (some>every, every>some)

Second, some adverbs, such as *cal* ‘well’, must follow the object NP in transitive sentences, as illustrated in (38). Assuming that this type of adverb is VP-adjoined, the examples in (38) provide support for the view that objects raise from a VP-internal position to a functional projection higher in the clause structure (Hagstrom 2000, 2002).⁵

- (38) a. Toli-ka maykcwu-lul cal masi-n-ta. (S O Adv V)
 Toli-NOM beer-ACC well drink-PRES-DECL
 ‘Toli drinks beer well.’
- b. *Toli-ka cal maykcwu-lul masi-n-ta. (*S Adv O V)
 Toli-NOM well beer-ACC drink-PRES-DECL
 ‘Toli drinks beer well.’

Another argument comes from binding. In English, (39) is grammatical, indicating that the object *her* does not c-command into the adjunct clause, hence that *Mary* does not violate Principle C.

- (39) Sue said that [John hugged her_i [before Mary_i left]].

This kind of example can be applied to Korean to determine the height of the object NP. It is generally agreed that in Korean, long-distance scrambling is a type of \bar{A} -movement and therefore a constituent that has undergone long-distance scrambling can undergo reconstruction. What this means is that if the scrambled object originated from an A-position that can c-command into the

⁵ Adverbs such as *cal* ‘well’ are not clitics on the verb. For example, *cal* can be modified by or conjoined with another adverb, as in (i).

- (i) a. Toli-ka maykcwu-lul acwu cal masi-n-ta.
 Toli-NOM beer-ACC very well drink-PRES-DECL
 ‘Toli drinks beer very well.’
- b. Toli-ka maykcwu-lul cal kuliko cacwu masi-n-ta.
 Toli-NOM beer-ACC well and often drink-PRES-DECL
 ‘Toli drinks beer well and often.’

A reviewer observes that when *cal* is modified by or conjoined with other adverbs, it seems all right to place the resulting AdvP in front of the object NP, as in (ii).

- (ii) a. ?Toli-ka acwu cal maykcwu-lul masi-n-ta.
 Toli-NOM very well beer-ACC drink-PRES-DECL
 ‘Toli drinks beer very well.’
- b. ?Toli-ka cal kuliko cacwu maykcwu-lul masi-n-ta.
 Toli-NOM well and often beer-ACC drink-PRES-DECL
 ‘Toli drinks beer well and often.’

Although the grammaticality of (ii) is not as degraded as that of (38b), the native speakers we consulted agreed that (i) is still better than (ii). They also thought that the examples in (ii) require an intonational pattern distinct from that of the examples in (i). Given this, these modified/conjoined adverbs probably occur as parentheticals higher in the clause structure than the unmodified/unconjoined ones.

adjunct clause (namely, the object-raised position), then a Korean example corresponding to (39), with long-distance object scrambling, would be degraded, because it would contain a Principle C violation. This prediction is borne out, as shown in (40).

- (40) *Kunye-lul_i Sue-nun [Toli-ka t_i [Mary-ka_i kaki ceney] kkyean-ass-tako]
 she-ACC Sue-TOP Toli-NOM Mary-NOM leave before hug-PST-COMP
 malha-yess-ta.
 say-PST-DECL
 ‘Sue said that Toli hugged her before Mary left.’

Third, short negation has the morphosyntactic status of a clitic, as in many Romance languages (Cinque 1999), and is treated as a unit with the verb in overt syntax. Short negation *an* must occur immediately before the verb in adult Korean. Nothing can intervene between short negation and the verb (see (41)–(42)); and, in coordinate-VP structures, short negation cannot stand alone in the first conjunct (see (43)).⁶

- (41) a. Toli-ka maykcwu-lul *an* masi-n-ta. (S O Neg V)
 Toli-NOM beer-ACC NEG drink-PRES-DECL
 ‘Toli doesn’t drink beer.’
 b. *Toli-ka *an* maykcwu-lul masi-n-ta. (*S Neg O V)
 Toli-NOM NEG beer-ACC drink-PRES-DECL
 ‘Toli doesn’t drink beer.’
- (42) a. Toli-ka maykcwu-lul *cal an* mas-in-ta. (S O Adv Neg V)
 Toli-NOM beer-ACC well NEG drink-PRES-DECL
 ‘Toli doesn’t drink beer well.’
 b. *Toli-ka maykcwu-lul *an cal* mas-in-ta. (*S O Neg Adv V)
 Toli-NOM beer-ACC NEG well drink-PRES-DECL
 ‘Toli doesn’t drink beer well.’
- (43) a. Toli-ka khwukhi-lul ppali kuliko keyiku-lul chenchehi *an* mek-ess-ta.
 Toli-NOM cookie-ACC quickly and cake-ACC slowly NEG eat-PST-DECL
 ‘Toli didn’t eat cookies quickly and he didn’t eat cake slowly.’
 b. *Toli-ka khwukhi-lul ppali *an* kuliko keyiku-lul chenchehi *an* mek-ess-ta.
 Toli-NOM cookie-ACC quickly NEG and cake-ACC slowly NEG eat-PST-DECL
 ‘Toli didn’t eat cookies quickly and he didn’t eat cake slowly.’

⁶ A reviewer notes that examples like (43a) may constitute an argument for V-raising, as one can say that the verb along with negation has undergone ATB raising. The same reviewer also notes that examples like (43a) are still grammatical when the negation marker is taken out, as in (i).

- (i) Toli-ka khwukhi-lul ppali kuliko keyiku-lul chenchehi mek-ess-ta.
 Toli-NOM cookie-ACC quickly and cake-ACC slowly eat-PST-DECL
 ‘Toli ate cookies quickly and ate cake slowly.’

The reviewer suggests that this kind of example is derived by an ATB V-raising, hence gives evidence for overt V-raising in Korean, going back to Koizumi’s (2000) argument. But in section 2.2, we already considered similar examples (see (11)–(12)) and noted that ATB extraposition is not restricted to the verb alone (see (13)–(14)); as a result, examples like (i), (43a), and the examples considered in section 2.2 do not have any bearing on the issue of V-raising.

Because of this tight relationship between short negation and the verb, some researchers (No 1988, Kim 2000b) have argued that short negation is a prefixal bound morpheme on the verb and cannot host an independent syntactic projection. However, the fact that children (2 and 3 years of age) sometimes fail to put together short negation and the verb, as shown in (44) (Hahn 1981, Cho and Hong 1988, Kim 1997, Baek 1998, Hagstrom 2002), undermines the prefixal bound morpheme approach to short negation.

(44) *Sentences produced by 2- and 3-year-old Korean-speaking children*

- a. Na *an* pap mek-e.
I NEG rice eat-DECL
'I will not eat rice.' (Cho and Hong 1988)
- b. An mak uwl-e.
NEG much cry-DECL
'(I) do not cry much.' (Cho and Hong 1988)
- c. An kyelan mek-e.
NEG egg eat-DECL
'(I) won't eat eggs.' (Hahn 1981)
- d. An kkum kkwe-ese . . .
NEG dream dream-because
'Because (I) did not dream . . . ' (Kim 1997)

This type of acquisition data supports an analysis of short negation as an independent lexical item with a projection of its own. If short negation is the clitic head of a separate projection and if children have trouble recognizing that it is a clitic, then they should produce sentences like (44a–d). Since they do produce such sentences, we have evidence that they know where to generate short negation, but not that it is a clitic. Hence, these child utterances tell us where short negation really is in the adult grammar, assuming that children's phrase structures are continuous with adults'. We can conclude from these data that the base position of short negation is to the left of the object, just like that of VP-adjoined adverbs, and that children go through a stage in which they fail to cliticize short negation onto the verb (Han and Park 1994).

Taken together, these observations suggest that scope facts in sentences containing both short negation and a quantified object NP could provide a clear test for the height of the verb. Given the scope-freezing effect, the scope of an argument QP will be determined by its surface position, without recourse to quantifier raising or reconstruction. This then means that it is the position of negation in the clause structure that determines the relative scope of negation and an argument QP.⁷ Finally, given that objects obligatorily raise out of the VP and that short negation is a unit with the verb, the relative scope of negation and an object QP will tell us whether the verb has raised. If the verb raises, then negation (cliticized to the verb) will occur in a position higher than an object QP and will therefore take scope over this QP. On the other hand, if the verb remains in VP, then negation will also remain in VP and the object QP will take scope over negation.

⁷ A reviewer questions our assumption that the scope of negation in relation to a scope-freezing QP is determined by the position of negation in the overt syntax. The data that we obtained from our experiments support our assumption.

In order to make these predictions more precise, we postulate the clause structure for Korean shown below. Long negation heads its own projection NegP (45a), and short negation is adjoined to VP (45b).⁸ The subject NP is higher up, in Spec,IP. For the purposes of this article, we take no stand on whether the subject is base-generated in Spec,IP or whether it is generated lower in

as discussed in sections 4.1.5 and 4.1.6. We found that when it comes to negative sentences with a scope-freezing subject QP, our participants virtually never accepted the $\text{neg} > \forall$ interpretation and always accepted the $\forall > \text{neg}$ interpretation, regardless of negation type. This suggests that the scope of negation is also determined by its position in the overt syntax, a position c-commanded by the subject.

The same reviewer also notes that at least in Japanese, some quantifiers do not exhibit frozen scope, citing Saito 1997. For instance, in contrast to the scope of *daremo* 'every' in (i), the scope of *minna* 'every' in (ii) is not frozen and so (ii) is scopally ambiguous. Therefore, a proper characterization of the frozen scope property is that it is a property of certain quantifiers and not of the language in general.

- (i) Dareka-ga daremo-o aisiteiru.
 someone-NOM everyone-ACC love-PRES
 'Someone loves everyone.' (some > every, *every > some)
- (ii) Dareka-ga minna-o aisiteiru.
 someone-NOM everyone-ACC love-PRES
 'Someone loves everyone.' (some > every, every > some)

This does not undermine the argument we are making here, however. As long as there is a quantifier that independently exhibits the frozen scope property, we can maintain that negative sentences containing those scope-freezing quantifiers can be used to test the height of the verb. Moreover, the fact that only certain quantifiers show frozen scope effects further underscores our claim that evidence for verb placement in Korean is difficult for learners to find. This is because the relevant evidence about scope with respect to negation would be accessible to a learner only after he or she had identified which quantifiers show frozen scope and which quantifiers do not.

⁸ In sentences with long negation, the main verb is inflected with *-ci*, as can be seen in (33), repeated here as (i). A reviewer asks where *-ci* appears in the clause structure.

- (i) *Korean long negation*
 Toli-ka ttena-ci ani ha-yess-ta.
 Toli-NOM leave-CI NEG do-PST-DECL
 'Toli didn't leave.'

One of the main views on *-ci* is that it is a nominalizer that introduces a new clause (Hagstrom 2002 and references therein). Under this view, a sentence with long negation would be a complex clause, with *-ci* heading an embedded clause. But this analysis does not mesh well with the way NPI-licensing works in Korean. As discussed in sections 2.3 and 2.4, NPIs in Korean are licensed by negation in the same clause. If *-ci* is a nominalizer that introduces a new clause, then in examples such as (ii), an NPI in object position would belong to a different clause from long negation, as indicated by the bracketing. This then predicts that the NPI should not be licensed by long negation. But this is not true, as (ii) demonstrates.

- (ii) Toli-ka [amwukesto mek-ci] ani ha-yess-ta.
 Toli-NOM anything eat-CI NEG do-PST-DECL
 'Toli didn't eat anything.'

In contrast, an NPI in a truly nominalized clause cannot be licensed by negation in the higher clause.

- (iii) *Toli-ka [amwukesto mek-ki-lul] an wonha-n-ta.
 Toli-NOM anything eat-NMZ-ACC NEG want-PRES-DECL
 'Toli does not want to eat anything.'

In light of this fact, we treat *-ci* as an inflection on the verb, and not as a nominalizer that projects its own syntactic projection. In Korean, as in English, auxiliary verbs select for a particular inflection on the main verb. For example, *issta* 'be-DECL', with a similar usage as English progressive *be*, selects for *-ko* on the main verb, as in (iv). We can think of *-ci* in a similar light: that is, it is an inflection on the verb selected by negation.

- (iv) Toli-ka mantwu-lul mek-ko iss-ta.
 Toli-NOM dumplings-ACC eat-KO be-DECL
 'Toli is eating dumplings.'

the clause within VP and moves up to Spec,IP. What is important here is that it ends up higher in the clause structure than the object NP and the two types of negation. Further, as we will show in section 4, placing the subject high in the clause structure makes the right predictions with respect to the scopal interaction between the subject QP and negation.⁹ The object NP originates within VP but moves to a functional projection outside VP, presumably for Case reasons. We will refer to this functional projection as *FP*, for lack of a better term. We can think of this FP as serving a similar syntactic function as the target position of object shift seen in many Germanic languages (see Bobaljik and Jonas 1996). These are represented in (45a–b). Moreover, assuming that short negation undergoes cliticization onto the verb in overt syntax, as Cinque (1999) proposes for negation in Romance, if the verb undergoes raising, then short negation would end up high in the clause structure with the verb, as represented in (45c).¹⁰

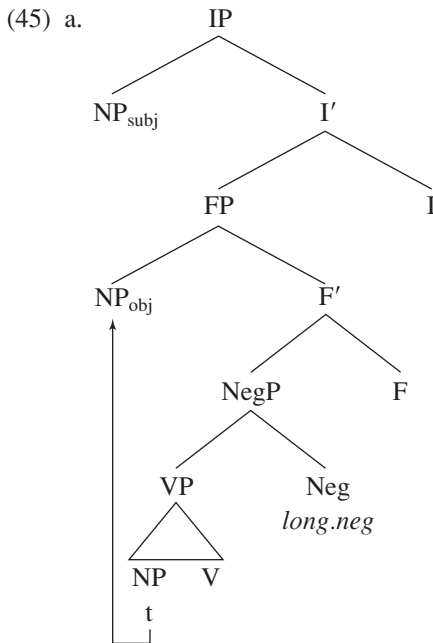

⁹ A reviewer correctly points out that in languages like Korean and Japanese, the issue of subject raising to IP is an open problem. Debates on this issue date back to Fukui 1986, Kuroda 1988, and Heycock and Lee 1989, and so far no convincing evidence has been found to support subject raising out of VP/vP in these languages. In our account, placing the subject outside of VP is a consequence of placing the negation projection above VP, and as we will show in section 4, placing the subject higher in the clause than the two types of negation makes the right predictions for scope with respect to negation. If indeed the subject stays within VP/vP, then the implication for the analysis we are pursuing would be that the VP/vP projection is more articulated than assumed here, with negation projections, VP/vP-internal object NP-raising, and possibly VP/vP-internal V-raising.

¹⁰ A reviewer asks what the exact nature of the trace left by short negation is in (45c). In our account, the sole purpose of inserting this trace in the tree is to indicate the original position of short negation before it undergoes cliticization onto the verb. It has no further theoretical implications.

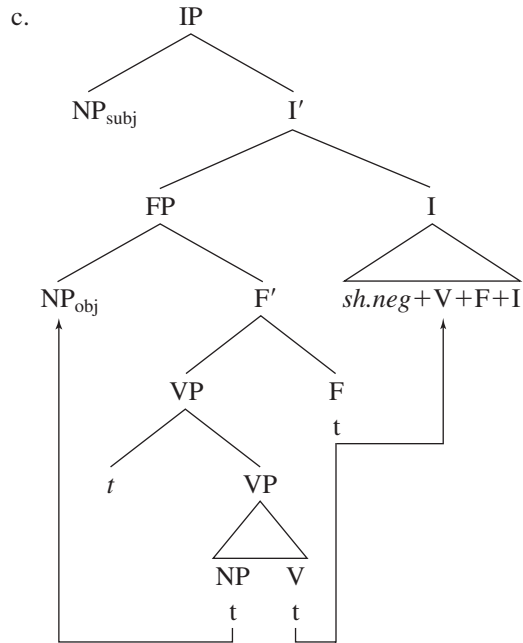
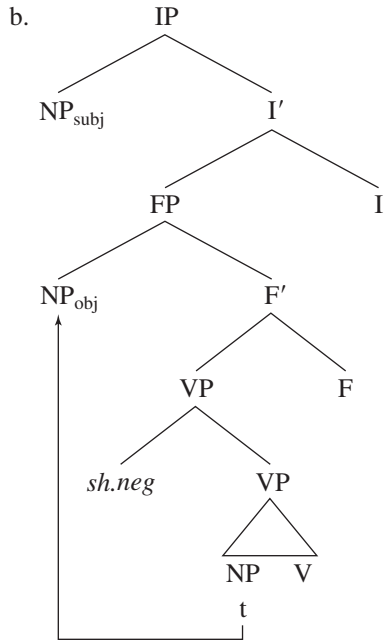

Given the structures in (45), the following predictions clearly emerge:¹¹

(46) *Predictions*

- a. Subject QPs will take scope over Neg, regardless of negation type.
- b. In the case of short negation,
 - i. if there is V-raising, then Neg+V will occur in IP and so Neg will take scope over object QPs;
 - ii. if there is no V-raising, then Neg+V will occur inside VP and object QPs will take scope over Neg.

Even given these clear predictions, however, a problem remains about data. Linguists studying Korean cannot reach a consensus on what the scope facts are.

3.3 *Conflicting Claims in the Literature*

The scope judgments reported in the literature for sentences containing negation and quantified argument NPs often conflict with each other. While most authors agree that both types of negation can take narrow scope with respect to both subject and object QPs, there is little agreement about the availability of the wide scope reading of negation.

First, examining sentences with a subject-oriented adverbial QP *ta* ‘all’, as in (47), Suh (1989) and H.-H. Park (1998) report that while sentences with short negation exhibit only the ‘all>neg’ reading, sentences with long negation exhibit both the ‘all>neg’ and ‘neg>all’ readings.¹² On the other hand, Kim (2000a) reports that sentences with long or short negation allow both the ‘all>neg’ and ‘neg>all’ readings. Their judgments are summarized in table 1.

¹¹ A reviewer asks what the expected structure of sentences containing both short and long negation is, under the assumptions in (45). The clause structure of such sentences (one of which is (36), repeated here as (i)) will contain projections for both short and long negation, as shown in (ii). Since the two negations are in the same clause, they cancel each other out, resulting in the affirmative meaning paraphrased in (i).

(i) Toli-ka maykcwu-lul an masi-ci ani ha-yess-ta.
 Toli-NOM beer-ACC NEG drink-CI NEG do-PST-DECL
 ‘Toli didn’t not drink beer.’ (Toli drank beer)

(ii) [_{IP} Toli-ka [_{FP} maykcwu-lul_i [_{NEG}P [_{VP} *sh.neg* [_{VP} _{t_i} V]]] *long.neg*] F] I]

The same reviewer asks how we would handle coordinated examples containing an untensed and a tensed conjunct clause, where both the clauses are negated, as in (iii).

(iii) Ku-nun [_{IP} mal-to an ha-ko] pap-to an mek-ess-ta.
 he-TOP speech-also NEG do-CONJ meal-also NEG eat-PST-DECL
 ‘He didn’t speak and didn’t eat the meal.’

In our account, as we argued in section 2.4, the untensed conjunct is syntactically an adjunct clause. Therefore, in examples like (iii), both the adjunct clause and the matrix clause contain negation. Given that the two negations are in separate clauses, they do not interact with each other and so the meaning of negation in the adjunct clause is preserved.

¹² A reviewer points out that *ta* ‘all’ is not always subject-oriented. This is correct. The discussion regarding (47) is intended to present what the literature reports on scope between *ta* and negation when *ta* is used as a subject-oriented quantifier.

Table 1
Judgments: Subject-oriented adverbial QP

	Suh 1989, H.-H. Park 1998		Kim 2000a	
	'all>neg'	'neg>all'	'all>neg'	'neg>all'
Short neg	yes	no	yes	yes
Long neg	yes	yes	yes	yes

(47) *Subject-oriented adverbial QP*

- a. Ta an o-ass-ta.
all NEG come-PST-DECL
'All didn't come.' (short negation)
- b. Ta o-ci ani ha-yess-ta.
all come-CI NEG do-PST-DECL
'All didn't come.' (long negation)

Second, using examples with an object-oriented adverbial QP as in (48), Cho (1975) reports that while sentences with long negation are ambiguous between the 'two>neg' and 'neg>two' readings, sentences with short negation have only the 'two>neg' reading. But Song (1982) reports that sentences with long and short negation are ambiguous between the 'two>neg' and 'neg>two' readings. These judgments are summarized in table 2.

(48) *Object-oriented adverbial QP*

- a. John-i sakwa-lul twu kay an mek-ess-ta.
John-NOM apple-ACC two piece NEG eat-PST-DECL
'John didn't eat two apples.' (short negation)
- b. John-i sakwa-lul twu kay mek-ci ani ha-yess-ta.
John-NOM apple-ACC two piece eat-CI NEG do-PST-DECL
'John didn't eat two apples.' (long negation)

Third, using examples with a universal quantifier in object position as in (49), Hagstrom (2000) and Suh (1989) report that whereas sentences with short negation have only the 'every>neg' reading, sentences with long negation have both the 'every>neg' and 'neg>every' read-

Table 2
Judgments: Object-oriented adverbial QP

	Cho 1975		Song 1982	
	'two>neg'	'neg>two'	'two>neg'	'neg>two'
Short neg	yes	no	yes	yes
Long neg	yes	yes	yes	yes

Table 3

Judgments: Universal quantifier in object position

	Suh 1989, Hagstrom 2000		Baek 1998, Kim 2000a	
	'every>neg'	'neg>every'	'every>neg'	'neg>every'
Short neg	yes	no	yes	yes
Long neg	yes	yes	yes	yes

ings. But Baek (1998) and Kim (2000a) report that sentences with either short or long negation allow both the 'every>neg' and 'neg>every' readings. Their judgments are summarized in table 3.

(49) *Universal quantifier in object position*

- a. John-i motun chayk-ul an ilk-ess ta.
 John-NOM every book-ACC NEG read-PST-DECL
 'John didn't read every book.' (short negation)
- b. John-i motun chayk-ul ilk-ci ani ha-yess-ta.
 John-NOM every book-ACC read-CI NEG do-PST-DECL
 'John didn't read every book.' (long negation)

Finally, using examples with a universal quantifier in subject position as in (50), Hagstrom (2000) reports that sentences with long negation are ambiguous between 'every>neg' and 'neg>every' readings, but sentences with short negation have only the 'every>neg' reading. Baek (1998) and Kim (2000a) report that sentences with short negation as well as those with long negation are ambiguous. Yet another pattern is reported by Suh (1989): namely, that both sentences with short negation and sentences with long negation can have only the 'every>neg' reading. These judgments are summarized in table 4.

(50) *Universal quantifier in subject position*

- a. Motun salam-i yeki-e an o-ass-ta.
 every person-NOM here-to NEG come-PST-DECL
 'Every person didn't come here.' (short negation)
- b. Motun salam-i yeki-e o-ci ani ha-yess-ta.
 every person-NOM here-to come-CI NEG do-PST-DECL
 'Every person didn't come here.' (long negation)

Table 4

Judgments: Universal quantifier in subject position

	Hagstrom 2000		Baek 1998, Kim 2000a		Suh 1989	
	'every>neg'	'neg>every'	'every>neg'	'neg>every'	'every>neg'	'neg>every'
Short neg	yes	no	yes	yes	yes	no
Long neg	yes	yes	yes	yes	yes	no

Given the conflicting scope judgments found in the literature on Korean, one would be hard pressed to draw any firm conclusions about V-raising. Why is there such disagreement on these facts? One possibility is that the disagreement arises from a methodological problem: perhaps some speakers are better able than others to imagine the contexts that make certain readings available; or perhaps some speakers are influenced by their knowledge of logic or of other languages in making grammaticality judgments. Another possibility is that the variation reflects a genuine fact about Korean speakers' grammars: specifically, it is possible that different speakers have different grammars with respect to V-movement, leading in turn to different scope judgments in sentences involving the relevant scope interactions. In the next section, we address this issue by controlling the context of presentation so as to yield what we believe are judgments that clearly illustrate speakers' grammars.

4 Experimental Investigations

So far, we have shown that even though scope interactions between negation and quantified argument NPs should provide a clear test for V-raising, conflicting scope judgments reported in the literature make it impossible for us to draw any firm conclusions. Conceivably, this disagreement in judgments was caused by the method used to elicit judgments from the native speakers; that is, insufficient discourse context may have limited the availability of possible readings for some speakers. To avoid this problem, we obtained scope judgments from speakers of Korean using the truth-value judgment task (TVJT) (Crain and Thornton 1998). Because this method reduces the role of performance factors in accessing speakers' intuitions and holds discourse context constant (Crain and Thornton 1998), experimentation using this method should provide data that accurately reflect the participants' grammars.

The TVJT involves two experimenters. One experimenter acts out short scenarios in front of the participant using small toys and props. The other experimenter plays the role of a puppet (e.g., Mickey Mouse) who watches the scenario alongside the participant. At the end of the story, the puppet makes a statement about what he thinks happened in the story. The participant's task is to determine whether the puppet told the truth or not.

For instance, to test how speakers of English would interpret a negative sentence with a quantified subject such as *Every horse didn't jump over the fence*, an experimenter enacts a scenario in which two toy horses jump over a toy fence, but a third toy horse does not. In this situation, *Every horse didn't jump over the fence* is true on the interpretation where negation takes scope over the subject QP ('not>every') but false if the subject QP is interpreted outside the scope of negation ('every>not'). A detailed context for this scenario is given in (51), and a screen shot of the resulting scenario is shown in figure 1.

(51) *Example context*

One day three horses were playing in the field and they decided to jump over some stuff. There was a house and a fence in the yard. They decided that the house was too high to jump over and so they decided to try jumping over the fence. Two of them were very excited about jumping over the fence but the third wasn't sure whether he



Figure 1

Screen shot of a scenario

could. The first one jumped over the fence. “Hey, that was fun,” he said. “You try it.” Then the second horse also jumped over the fence. The third one came up to fence and considered jumping but he said that he had hurt his foot the day before and so decided not to jump.

Another experimenter holds a Mickey Mouse puppet, acting as if he is watching the enacted scenario. Mickey, who is asked to describe what happened, then makes the following statement:

(52) *Puppet statement*

Hmm. That was an interesting story about horses playing in the field. I can tell you something about the story. *Every horse didn't jump over the fence.* Am I right?

The participant’s task is to determine whether Mickey’s statement is true or false. If a participant judges the statement to be true, then we can conclude that the participant’s grammar makes available the reading on which negation takes scope over the quantified NP. If a participant judges the statement to be false, then we can conclude that the participant’s grammar makes only the narrow scope reading of negation available and does not generate the other reading. An important part of the reasoning behind this method is that participants will always assent when the experimenter says at least one thing that is true (Crain and Thornton 1998). In other words, the method relies on listeners’ giving speakers the benefit of the doubt. Hence, if anything that the speaker says is true, then participants respond by saying that the speaker did in fact speak truthfully. Thus, when we present a statement that is true on one reading but false on another and the participant rejects the statement as false, we conclude that the other reading is not available.

The TVJT method provides rich discourse contexts, eliminating the role of performance factors and controlling for discourse factors in participants’ responses. The method has been shown to work in several languages (e.g., Lidz and Musolino 2002, Papafragou and Musolino 2003) and to work both with adults and with children as young as 4 (Crain and McKee 1986, Crain and Thornton 1998, Lidz and Musolino 2002).

Our experiments were designed for three purposes: (a) to determine experimentally what the facts are concerning adult Korean speakers' scope judgments on sentences containing negation and quantified argument NPs, (b) to determine whether Korean has V-raising, and (c) to test predictions regarding children's grammar made on the basis of the data we obtained from adults.

To pursue these goals, we conducted two experiments, one with adults and the other with 4-year-olds.

4.1 Experiment 1

4.1.1 Participants We tested 160 adult speakers of Korean, all undergraduate or graduate students at universities in Seoul, Korea.¹³

4.1.2 Experimental Design For adults, we tested three factors with two levels each: scope (neg>∀ vs. ∀>neg) × negation (long vs. short) × grammatical function (subject QP vs. object QP). The experiment was thus divided into eight different conditions, each condition testing for the neg>∀ or ∀>neg reading in sentences containing long or short negation, and either a subject QP or an object QP. Twenty participants were assigned to each condition. The design is summarized in table 5.

Since the puppet's statements on critical trials are potentially ambiguous, we chose to treat the scope condition as a between-participants factor, instead of a within-participants factor, in order to avoid potential contaminating effects between the two possible readings. That is, once participants become aware of one of the possible interpretations for these statements, they may later find it difficult to assign a similar statement a different interpretation. In other words, the initial interpretation that participants assign to statements containing a QP and negation may influence the way they interpret subsequent statements containing the same elements.

4.1.3 Materials We constructed two versions of each scenario, one version testing the neg>∀ reading and the other version testing the ∀>neg reading. There were four different types of test sentence for each reading: (a) subject QP and long negation as in (53a), (b) subject QP and short negation as in (53b), (c) object QP and long negation as in (54a), and (d) object QP and short negation as in (54b).¹⁴

¹³ For helping us recruit participants, we thank Chungmin Lee and Eun-Jung Yoo at Seoul National University, Chang-Bong Lee and Jae-ah Jeon at Catholic University, Hyunoo Lee at Inha University, and Jae-Woong Choe at Korea University.

¹⁴ For many Korean speakers, a more natural way of expressing universal quantification is to use postnominal quantifiers like *ta* or *motwu*. The problem with these quantifiers for present purposes is that syntactically they are floating adverbial quantifiers and they do not form a constituent with the noun they modify. For instance, an adverb can intervene between a postnominal quantifier and the noun it modifies, as in (i).

(i) Khwukhi Monste-ka khwukhi-lul tahaynghito ta an mek-ess-ta.
 Cookie MONSTER-NOM cookie-ACC fortunately all NEG eat-PST-DECL
 'Cookie Monster didn't eat every cookie, fortunately.'

This means that the quantifier can stay low within VP, below negation, so that the 'neg>all' reading, if available, cannot be attributed to V-raising. For this reason, in our test sentences we chose to use prenominal quantifiers, which form a constituent with the noun they modify.

Table 5

Design of experiment with adults

$2 \times 2 \times 2$ design:	negation type (short vs. long)	×	QP position (subject vs. object)	×	scope (neg>∀ vs. ∀>neg)
Grammatical function	Scope		Short negation		Long negation
Subject QP	neg>∀		$n = 20$		$n = 20$
	∀>neg		$n = 20$		$n = 20$
Object QP	neg>∀		$n = 20$		$n = 20$
	∀>neg		$n = 20$		$n = 20$

(53) *Subject QPs*

- a. Motun mal-i wultali-lul num-ci ani ha-yess-ta.
 every horse-NOM fence-ACC jump.OVER-CI NEG do-PST-DECL
 ‘Every horse didn’t jump over the fence.’ (long negation)
- b. Motun mal-i wultali-lul an num-ess-ta.
 every horse-NOM fence-ACC NEG jump.OVER-PST-DECL
 ‘Every horse didn’t jump over the fence.’ (short negation)

(54) *Object QPs*

- a. Khwukhi Monste-ka motun khwukhi-lul mek-ci ani ha-yess-ta.
 Cookie Monster-NOM every cookie-ACC eat-CI NEG do-PST-DECL
 ‘Cookie Monster didn’t eat every cookie.’ (long negation)
- b. Khwukhi Monste-ka motun khwukhi-lul an mek-ess-ta.
 Cookie Monster-NOM every cookie-ACC NEG eat-PST-DECL
 ‘Cookie Monster didn’t eat every cookie.’ (short negation)

In the scenario that tests the neg>∀ reading on the basis of (53a) and (53b), three horses are playing together. Two horses jump over the fence, but the third one doesn’t. At the end of the story, Mickey Mouse says in Korean, “I know what happened,” and states either (53a) or (53b), depending on what condition is being tested. In the scenario that tests the ∀>neg reading, none of the horses jump over the fence. Mickey Mouse then describes the situation using either (53a) or (53b).¹⁵

In the scenario that tests the neg>∀ reading on the basis of (54a) and (54b), Cookie Monster is given three cookies but only eats two of them (i.e., not all of them). Mickey Mouse then

¹⁵ The experimenter was instructed to say the test sentence in a way that made it true, thus controlling for any potentially contaminating effects of prosody. For adult participants, all the test sentences were presented in prerecorded video clips, as a further measure to keep the effects of intonation, if any, constant. In light of the findings reported by McMahon, Lidz, and Pierrehumbert (2004), however, we do not think it likely that the results obtained from our experiments were influenced by any prosodic factors. These authors show that in English, speakers do not reliably produce intonational or prosodic cues to scopal interpretation in the kinds of sentences similar in form to our test sentences, suggesting that intonation is not a factor in guiding either children’s or adults’ behavior in tasks similar to the ones in our experiments.

describes the situation using (54a) or (54b), depending on the condition. In the scenario that tests the $\forall > \text{neg}$ reading, Cookie Monster eats none of the cookies, and then Mickey Mouse describes the situation using (54a) or (54b).

Each participant was given four test trials. The statements made by Mickey Mouse in the eight different conditions are given in appendix A. In addition to the four test trials, each participant was given four filler trials: two testing comprehension of negation, and two testing comprehension of quantified NPs. The purpose of the filler trials is to separately control for participants' knowledge of the meaning of negation and their knowledge of universally quantified NPs, the two linguistic elements involved in the meaning of the test sentences. Filler sentences containing long negation were given to participants in the short negation condition, and those containing short negation were given to participants in the long negation condition. By using the opposite negation form in the filler items and the test items, we add some variety to the materials, thereby making it harder for participants to guess the purpose of the experiment. Similarly, filler sentences containing subject QPs were given to participants in the object QP condition, and those containing object QPs were given to participants in the subject QP condition. As with negation, including quantifiers in the fillers with the opposite grammatical function from that of the quantifiers in the test items helped mask the purpose of the experiment. The filler statements made by Mickey Mouse in each condition are given in appendix B. We set up the scenarios for the filler trials such that the correct answer for the filler statements was "true" in the subject QP – short neg – $\text{neg} > \forall$ and object QP – short neg – $\text{neg} > \forall$ conditions. This was because we expected the participants in these conditions were likely to say that the test items were false. Thus, including these fillers ensured that participants would not think the only possible answer in the experiment was "false." The fillers in the other six conditions were designed to give the answer "false."

4.1.4 Procedure Adult participants were shown a videotaped version of the scenarios described in section 4.1.3. They were first introduced to the task with two practice trials, one in which Mickey Mouse's statement was true and one in which it was false. They were then shown four test trials and four filler trials in pseudorandom order. They were given a score sheet and were instructed to indicate, for each story, whether Mickey Mouse spoke truthfully. They were asked to provide a brief justification for their answers. Adult participants were tested in groups of 10 to 20 in classrooms.

4.1.5 Results For each condition, our dependent measure was the proportion of "yes" responses to Mickey's statements. These data are given in table 6 and shown graphically in figures 2 and 3.

The proportion of "yes" responses was entered into an analysis of variance (ANOVA), which revealed the following effects. First, we found a main effect of interpretation ($F(1, 152) = 267.44$, $p < .0001$). That is, regardless of negation type or grammatical function, speakers were more likely to accept the $\forall > \text{neg}$ reading than the $\text{neg} > \forall$ reading. Second, we found a main effect of grammatical function ($F(1, 152) = 11.64$, $p < .0008$) and an interaction between interpretation and grammatical function ($F(1, 152) = 13.91$, $p < .0003$). That is, independently of negation type, speakers were significantly more likely to accept the $\text{neg} > \forall$ reading on an object QP than they

Table 6
Mean percentage acceptances by condition: Adults

Grammatical function	Scope	Short negation	Long negation
Subject QP	neg> \forall	4	19
	\forall >neg	100	100
Object QP	neg> \forall	37	46
	\forall >neg	98	98

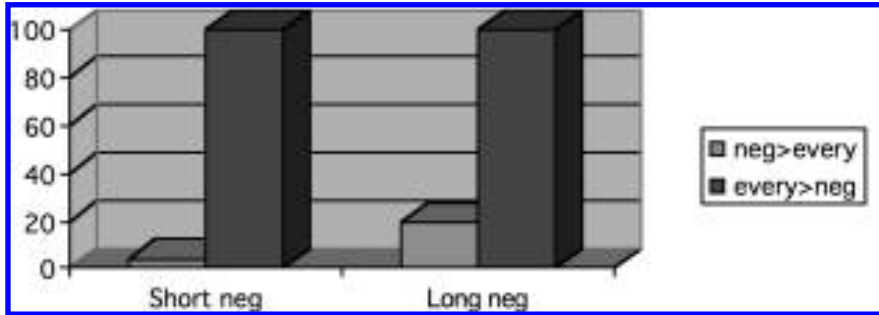

Figure 2
Mean percentage acceptances in subject condition: Adults

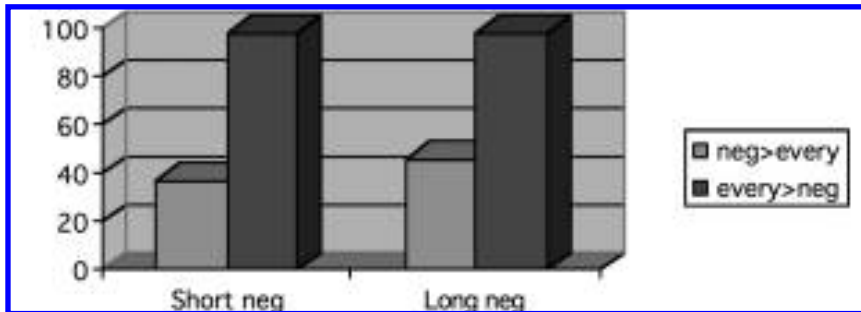

Figure 3
Mean percentage acceptances in object condition: Adults

were on a subject QP. Importantly, whereas the acceptance rate on the neg> \forall reading was higher in object conditions than in subject conditions, over 50% of the participants still did not accept this interpretation in object conditions.¹⁶

¹⁶ Participants were near perfect on filler items, indicating that they had no difficulty with the task or with negation or universal quantification in isolation.

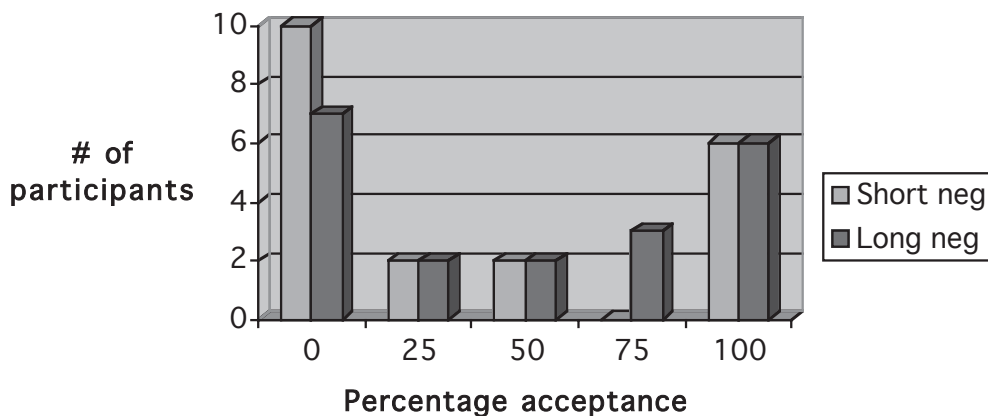

Figure 4

Number of participants accepting $\text{neg} > \mathbb{V}$ in object condition: Adults

This last result is of particular interest. Figure 4 divides the participants into groups based on their rate of acceptance of the sentences presented in the $\text{neg} > \mathbb{V}$ context in object conditions. As the figure shows, most participants either accepted all of these items or rejected all of them, indicating that our population is divided into two groups: speakers who accept wide scope negation relative to an object QP and those who do not.

4.1.6 *Discussion* Recall our predictions stated in (46), repeated here.

(55) *Predictions*

- a. Subject QPs will take scope over Neg, regardless of negation type.¹⁷
- b. In the case of short negation,
 - i. if there is V-raising, then $\text{Neg} + \mathbb{V}$ will occur in IP and so Neg will take scope over object QPs;
 - ii. if there is no V-raising, then $\text{Neg} + \mathbb{V}$ will occur inside VP and object QPs will take scope over Neg.

Prediction (55a) is borne out by our findings. Participants uniformly accepted the $\mathbb{V} > \text{neg}$ reading for subject QPs, regardless of negation type. Importantly, our data indicate that any variability found among linguists regarding the interpretation of subject QPs with respect to negation in

¹⁷ A reviewer asks how we can explain the conflicting judgments reported in the literature for the examples in (47) and (50), given the prediction in (55a). The conflicting judgments reported for (47) can still receive a structural explanation. The examples in (47) contain a floating adverbial quantifier *ta* 'all' and a pro subject. For these examples, then, a structure is available in which *ta* is low in the structure, as in *People did not all come*, corresponding to the $\text{neg} > \mathbb{V}$ reading, and one is available in which *ta* is high in the structure, as in *All people did not come*, corresponding to the $\mathbb{V} > \text{neg}$ reading. The TVJT experiments that we conducted here to sort out speakers' judgments suggest that the conflicting judgments reported in the literature for (50) are not reliable. As discussed in section 3, there may be many reasons why speakers give unreliable judgments, including a lack of sufficient discourse context and the influence of speakers' knowledge of logic or of other languages.

Korean must represent an artifact of data collection. Our participants virtually never accepted the $\text{neg} > \forall$ interpretation for subject QPs and always accepted the $\forall > \text{neg}$ interpretation. Furthermore, these data lend support to the reasoning by which we established our predictions. We showed that, given three basic facts (frozen scope, obligatory object raising, and the clitic status of negation), both a V-raising and an I-lowering grammar would predict that the subject obligatorily takes scope over negation.¹⁸ The fact that this prediction was borne out indicates that our use of scope interactions between the quantificational NPs and negation is appropriate for examining the height of the verb.

Prediction (55b), however, is the crucial piece of the puzzle, as it aims at teasing apart the difference between a V-raising and a non-V-raising grammar. What we found was that only about half of our participants accepted the $\text{neg} > \forall$ interpretation in which negation takes scope over the object QP. Furthermore, this split was also found in the $\text{neg} > \forall$ interpretation with long negation and an object QP.

The bimodal distribution in acceptance rates of the reading for object QPs shows that there is a split in the population: only about half of the Korean speakers allow negation to take scope over an object QP, regardless of negation type. In this case, we can conclude that the literature on Korean scope judgments for object QPs reflects real variability in the population of Korean speakers. The scope judgments that we elicited within rich discourse contexts showed the same kind of disagreement that is attested in the literature.

The split in the population can mean only one thing: there is a split in the grammar. That is, half of the population has acquired an I-lowering grammar and half of the population has acquired a V-raising grammar.¹⁹ The population that has acquired an I-lowering grammar does

¹⁸ A reviewer notes that in Japanese, negative sentences with a universally quantified subject exhibit different scope patterns depending on whether the subject is accompanied by a nominative case marker (i) or a topic marker (ii).

- (i) Minna-ga ko-na-katta.
everyone-NOM come-NEG-PST
'No one came.'
- (ii) Minna-wa ko-na-katta.
everyone-TOP come-NEG-PST
'Not everyone came. / No one came.'

The reviewer asks whether Korean exhibits similar contrasts and if so, how they should be analyzed. The corresponding pair of examples (iii)–(iv) in Korean does not seem to show the same contrast, according to the native speakers we consulted. Whether the subject QP has a nominative case marker or a topic marker, only the $\forall > \text{neg}$ reading seems to be readily available, regardless of negation type.

- (iii) Motun salam-i o-ci ani ha-yess-ta / an wa-ss-ta.
every person-NOM come-CI NEG do-PST-DECL / NEG come-PST-DECL
'No one came.'
- (iv) Motun salam-un o-ci ani ha-yess-ta / an wa-ss-ta.
every person-TOP come-CI NEG do-PST-DECL / NEG come-PST-DECL
'No one came.'

Admittedly, however, more careful elicitation of the readings is necessary to be sure. In fact, it would not be surprising to find some interpretational difference between topic-marked QPs and case-marked QPs. We think that the right way to approach this issue is by considering in detail the information structure and discourse functions represented by topic-marked NPs in comparison to case-marked NPs.

¹⁹ Note that the $\forall > \text{neg}$ reading entails the $\text{neg} > \forall$ reading. Thus, the fact that nearly 100% of our participants accepted the $\forall > \text{neg}$ reading in the object condition follows from the fact that this reading is consistent with either

not generate the $\text{neg} > \forall$ reading on an object QP because the grammar generates only the structure in which the object c-commands negation, as represented by grammar A in (56). In grammar A, sentences with short negation have cliticization of short negation and I-lowering to V, as in (56a), and sentences with long negation have cliticization of long negation and I-lowering to *ha* in F, as in (56b). But the population that has acquired a V-raising grammar generates the $\text{neg} > \forall$ reading for an object QP because the grammar generates the structure in which negation c-commands the object, as represented by grammar B in (57). In grammar B, sentences with short negation have cliticization of short negation to V and V-raising to I, as in (57a), and sentences with long negation have cliticization of long negation to *ha* in F and raising of *ha* to I as in (57b). The main verb V in (57b) does not move because *ha* in F, an auxiliary verb, is higher up in the structure, closer to I. This is what we find in other languages that have V-raising. For example, in French sentences with an auxiliary verb and a main verb, what raises is the auxiliary verb, not the main verb.²⁰

(56) Grammar A

- a. I lowers to V; short neg cliticizes to V; object takes scope over short neg.

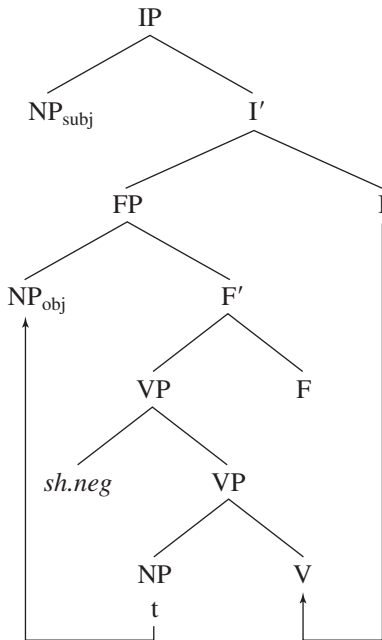

grammar. Those speakers with an I-lowering grammar will generate the $\forall > \text{neg}$ reading only. Those with a V-raising grammar will say that the puppet spoke truthfully in the $\forall > \text{neg}$ condition because these contexts are consistent with the $\text{neg} > \forall$ interpretation generated by their grammar.

²⁰ A question that arises about (57b) is why V cannot move over Neg to F and then onto I, in which case *ha* would not be required. It might be that *-ci* on the verb, which has been selected by long negation, prevents the verb from supporting further inflections, hence making it necessary for *ha* to be inserted in F.

- b. I lowers to *ha*; long neg cliticizes to *ha*; object takes scope over long neg.

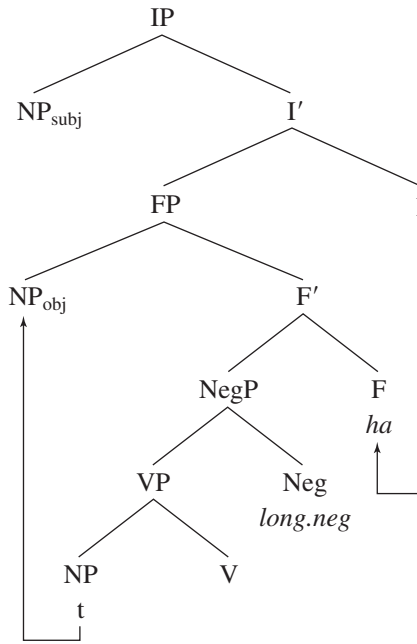

(57) Grammar B

- a. Short neg cliticizes to V; V raises to I; short neg takes scope over object.

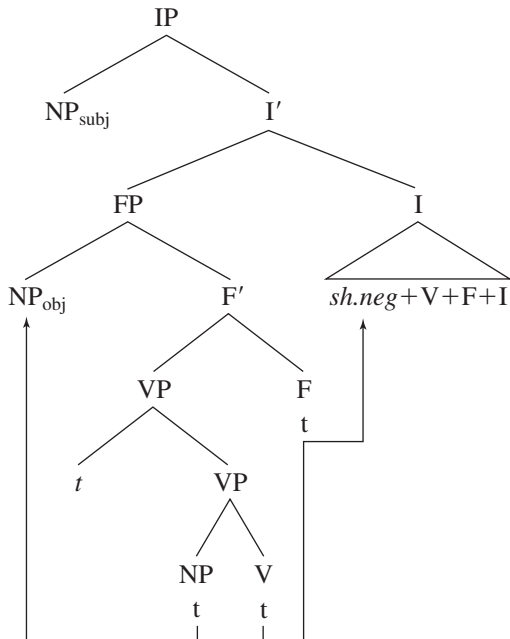

- b. Long neg cliticizes to *ha*; *ha* raises to I; long neg takes scope over object.

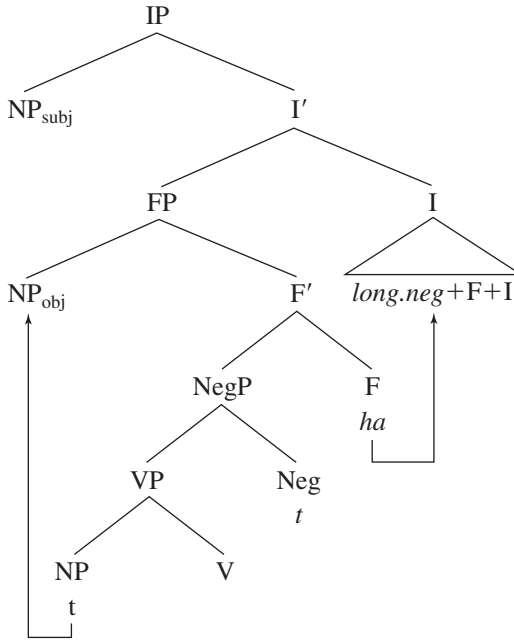

Finally, if our two-grammar hypothesis is correct, then it predicts that we should find the same split in the population among learners of Korean. If the split in the population derives from the fact that speakers are rarely exposed to sentences involving negation and an object QP in situations that make it clear which interpretation is intended, then we should expect to find roughly the same split in the population from generation to generation, with speakers choosing either V-raising or I-lowering basically at random. Our results from a study of 4-year-old children verify this prediction. Just like adults, children accepted the $\text{neg} > \forall$ reading only about half the time. And crucially, just like the adult data, the child data show a bimodal distribution of acceptances of the $\text{neg} > \forall$ reading.

4.2 Experiment 2

4.2.1 Participants We tested 60 4-year-old Korean children between the ages of 4;0 and 4;11 (mean 4;5), recruited from preschools in Korea. We chose 4-year-olds because at this age, Korean-speaking children are old enough to have mastered both negation forms (H.-H. Park 1998), and because crosslinguistically, 4-year-olds have been shown to be able to handle the demands of the task (Musolino, Crain, and Thornton 2000, for English; Lidz and Musolino 2002, for English and Kannada).

4.2.2 Experimental Design We tested two factors with two levels each: scope ($\text{neg} > \forall$ vs. $\forall > \text{neg}$) \times negation (long vs. short). All the tests were done on sentences with object QPs. Because the object conditions are the ones that are potentially informative about the height of the verb, we tested only these. The experiment was thus divided into four different conditions,

Table 7

Design of experiment with children

2 × 2 design:		negation type (short vs. long)	×	scope (neg>∀ vs. ∀>neg)
Grammatical function	Scope	Short negation		Long negation
Object QP	neg>∀	<i>n</i> = 15		<i>n</i> = 15
	∀>neg	<i>n</i> = 15		<i>n</i> = 15

each condition testing for the neg>∀ or the ∀>neg reading in sentences containing an object QP and long or short negation. Fifteen children were randomly assigned to each condition. The design is summarized in table 7.

4.2.3 Materials The test materials were identical to those in experiment 1 with the exception that the subject QP condition was excluded from the design.

4.2.4 Procedure Children were tested individually in a quiet room away from the class, and all the scenarios were acted out in front of them by an experimenter using small toys and props. As with adults, children were introduced to the task with two practice trials followed by four test and four filler trials in pseudorandom order. The children's responses were recorded on a score sheet by the experimenter. The experimenter also asked the children why they answered that Mickey was right or wrong, and recorded their responses.

4.2.5 Results The mean percentages of acceptances by condition for object QPs are summarized in table 8, and the graphical representation is given in figure 5.

Just like adults, children were more likely to accept the ∀>neg reading than the neg>∀ reading, regardless of negation type ($F(1, 56) = 20.09, p < .0001$). In the ∀>neg condition, children's rate of acceptance was 81.67% with short negation and 86.67% with long negation, whereas in the neg>∀ condition, their acceptance rate was 36.67% and 33.33% with short and long negation, respectively. Further, like adults, between one-third and one-half of the children accepted the neg>∀ reading with object QPs.²¹

Table 8Mean percentage acceptances by condition for object QPs:
Children

Scope	Short negation	Long negation
neg>∀	36.67	33.33
∀>neg	81.67	86.67

²¹ Like adults, child participants were near perfect on filler items, indicating that they had no difficulty with the task or with negation or universal quantification in isolation.

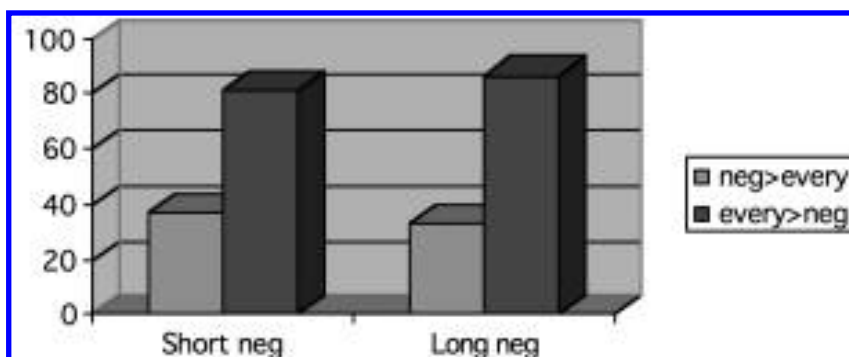

Figure 5

Mean percentage acceptances in object condition: Children

Like the adults', children's scores were bimodally distributed. That is, each child generally gave the same answer on all trials. Thus, the 36.67% acceptance rate for the $\text{neg} > \forall$ reading in short negation derives from 36.67% of the children accepting the $\text{neg} > \forall$ reading and not from each child accepting it 36.67% of the time. That is, in the short negation condition, 9 children never accepted the $\text{neg} > \forall$ reading, 1 child accepted it 50% of the time, and 5 children always accepted it. This finding supports our hypothesis that there are two grammars of Korean active in the population of Korean speakers: one grammar with V-raising and one without.

5 General Discussion

The results of our experiments with adults and children indicate that scope interactions between negation and quantified NPs are informative about the grammar of V-movement in Korean. More specifically, these data suggest that there are two grammars of Korean V-movement active in the population of Korean speakers. A remaining question is whether we can find other ways in which the two populations of Korean speakers differ. It is not obvious what that difference would be, though. If such independent evidence were readily available, then we would not expect to find a split in the population when it comes to parameter setting for verb placement. We have argued that the existence of two populations follows from the poverty of the stimulus. Even though the range of possible V-movement grammars is restricted by Universal Grammar, the data that learners of Korean are exposed to is equally consistent with either of two grammars. Given that there is no basis on which to make a choice between a V-raising grammar and an I-lowering grammar, Korean learners must choose at random. This results in roughly half the population acquiring one grammar and roughly half acquiring the other. This conclusion supports claims from the diachronic syntax literature (Kroch 1989, Pintzuk 1991, Santorini 1992, Taylor 1994) that even given the restricted hypothesis space determined by Universal Grammar, insufficient input can lead to distinct grammars in a single population. The general model under consideration here is one in which all language acquisition involves grammar competition (Kroch 1989, Roeper 1999, 2002,

Yang 2000; cf. Chomsky 1981, 1986). Under this approach, learners consider multiple grammars simultaneously, and language acquisition represents excluding alternatives and settling on a single grammar.

It is important to observe that the two-grammar result in Korean is not a direct consequence of the SOV nature of the language alone. It is possible for an SOV language to be unambiguously V-raising or I-lowering. It is also not the case that children learning any SOV language will be bimodally distributed in their responses in a TVJT examining the scope of an object QP with respect to negation. For example, Lidz and Musolino (2002) examined the scope of object quantifiers with respect to negation in English (SVO) and Kannada (SOV). Whereas adult speakers of either language allow either scope, children learning the languages display a strong preference for the surface scope reading. Although Kannada is an SOV language, we do not find any evidence of a split in the population with respect to V-raising. This result may derive from several factors. First, the scope of an object QP with respect to negation is generally determined by syntactic position (Lidz 1999, 2006).²²

- (58) a. Naanu cheenagi eradu pustaka ood-al-illa.
 I-NOM well two book read-INF-NEG²³
 ‘It’s not the case that I enjoyed reading two books.’
- b. Naanu eradu pustaka cheenagi ood-al-illa.
 I-NOM two book well read-INF-NEG
 ‘There are two books that I didn’t enjoy reading.’

In (58a), the object is inside VP (below the VP adverb) and is only interpretable as lying within the scope of negation. In (58b), the object has raised out of VP and takes scope only over negation. Because Kannada, unlike Korean, allows its object NPs to occur both inside and outside VP, the scope of an object NP with respect to negation is uninformative about the height of the verb.

Second, the fact that Kannada verbs typically inflect for tense and agreement (59a), but fail to do so in the presence of negation (59b), suggests that Kannada is a V-raising language and that raising is blocked by negation.

- (59) a. Naanu pustaka ood-id-e.
 I book read-PST-1s
 ‘I read a book.’

²² Note that syntactic position determines scope only for object NPs that are not morphologically case-marked. Case-marked object NPs take wide scope regardless of syntactic position.

- (i) Naanu cheenagi pustaka-vannu ood-al-illa.
 I well book-ACC read-INF-NEG
 ‘There is a book that I didn’t enjoy reading.’
- (ii) Naanu pustaka-vannu cheenagi ood-al-illa.
 I book-ACC well read-INF-NEG
 ‘There is a book that I didn’t enjoy reading.’

See Lidz 1999, 2006 for discussion.

²³ *INF* is an abbreviation for *infinitival*.

- b. Naanu pustaka ood-al-illa.
 I book read-INF-NEG
 'I did not read a book.'

This observation by itself may be a sufficient cue for learners to determine that Kannada has a V-raising grammar.

Third, Kannada exhibits a rule of emphatic verb formation that also supports a V-raising analysis. In this construction, a verb occurs in its past participle form, followed by the emphatic morpheme, the verb root (repeated), tense, and agreement (Aronoff and Sridhar 1983, Amritavalli 1998). This is illustrated in (60).

- (60) a. Bar-utt-aane.
 come-NPST-3SM
 'He comes.'
 b. Band-ee-bar-utt-aane.
 come.PP-EMPH-COME-NPST-3SM
 'He will too come.'

A straightforward analysis of this construction is one in which the verb raises to I, but must be pronounced both within VP to host the emphatic clitic and within I to host the tense and agreement morphology. This analysis is supported, with the additional assumption that negation blocks V-raising, by negative emphatics. Here, the verb does not repeat.

- (61) Band-ee-illa.
 come.PP-EMPH-NEG
 'He DID NOT come.'

The contrast between (60) and (61) may also serve as a cue to the V-raising status of Kannada, helping learners to uncover the correct grammar despite the SOV nature of the language.²⁴

²⁴ A reviewer notes that Korean has an emphatic verb formation that looks similar to the Kannada examples. As in Kannada, in Korean, the root verb can be repeated to convey emphasis in affirmative sentences, as shown in (i), but not in negative sentences, as shown in (ii).

- (i) Toli-ka o-ki-nun o-ass-ta.
 Toli-NOM come-KI-TOP come-PST-DECL
 'Toli CAME.'
 (ii) *Toli-ka an o-ki-nun o-ass-ta.
 Toli-NOM NEG come-KI-TOP come-PST-DECL
 'Toli did NOT come.'

However, Korean and Kannada emphatic verb formation differ in at least two crucial respects. First, Korean emphatic verb formation is possible with negative sentences; speakers can either use *ha* as a proform for negation as in (iii) or repeat negation along with the verb as in (iv). Second, in Korean, unlike in Kannada, materials other than the verb can be copied in emphatic verb formation. For instance, in (v), an adverb as well as the verb has been repeated. Taking these facts together, it is doubtful that emphatic verb formation in Korean has anything to do with V-raising.

- (iii) Toli-ka an o-ki-nun ha-yess-ta.
 Toli-NOM NEG come-KI-TOP do-PST-DECL
 'Toli did NOT come.'

Although it is true that V-raising may be harder to detect in SOV languages than in other languages, it is not the case that no cues exist. Rather, a host of other, unrelated properties make V-raising especially hard to detect in Korean. Consequently, we find that learners are unable to determine the “correct” grammar and hence choose essentially at random between two options, both of which are fully consistent with the language data they are exposed to.

This last point brings up an important question about the nature of the parameters that allow for the kind of variability we have observed here. Do all parameters allow for this kind of indeterminacy, or are some parameters special? In our view, there is nothing special about the V-raising parameter per se that leads to the observed split in the population. Rather, it is the relation between the parameter settings and strings of words in the language that is responsible for this variation. It is only when two parameter settings are equally compatible with the observed sentences that this kind of variability is expected to arise. Hence, we do not expect to find a subpopulation of English speakers, for example, with the “no movement” setting of the *wh*-movement parameter. This is because there is lots of positive evidence that would lead them to the right setting. It is only when two settings of a parameter predict nearly identical strings that we expect to find multiple grammars competing in a population. In other words, the smaller the set of sentences predicted by one setting but not the other, the greater the likelihood that multiple grammars will exist within a population. This is because as the area of nonoverlap between the two grammars shrinks, the less likely it is that a learner will be exposed to sentences in that area. As we have shown, the set of sentences that distinguishes a V-raising grammar from an I-lowering grammar in Korean is vanishingly small. Consequently, even learners with the highly restricted hypothesis space provided by Universal Grammar may have difficulty setting that parameter on the basis of positive evidence. In this situation, we expect, and indeed we find, that learners choose a parameter setting at random.

Appendix A: Test Sentences

This appendix provides the test sentences we used in each condition.

(62) *Subject QP – short neg – neg > V*; *subject QP – short neg – V > neg*

- a. Motun mal-i wulthali-lul an nem-ess-ta.
 every horse-NOM fence-ACC NEG jump.OVER-PST-DECL
 ‘Every horse didn’t jump over the fence.’

-
- (iv) Toli-ka an o-ki-nun an o-ass-ta.
 Toli-NOM NEG come-KI-TOP NEG come-PST-DECL
 ‘Toli did NOT come.’
- (v) Toli-ka ilccik o-ki-nun ilccik o-ass-ta.
 Toli-NOM early come-KI-TOP early come-PST-DECL
 ‘Toli DID come early.’

- b. Motun Smef-ka koyangi-lul an sa-ss-ta.
 every Smurf-NOM cat-ACC NEG buy-PST-DECL
 ‘Every Smurf didn’t buy a cat.’
- c. Motun yeca ai-ka toliki-lul an tha-ss-ta.
 every female kid-NOM merry-go-round-ACC NEG ride-PST-DECL
 ‘Every girl didn’t ride on the merry-go-round.’
- d. Motun namca-ka konglyong-ul an manci-ess-ta.
 every man-NOM dinosaur-ACC NEG pet-PST-DECL
 ‘Every man didn’t pet the dinosaur.’
- (63) *Subject QP – long neg – neg > V; subject QP – long neg – V > neg*
- a. Motun mal-i wulthali-lul nem-ci ani ha-yess-ta.
 every horse-NOM fence-ACC jump.OVER-CI NEG do-PST-DECL
 ‘Every horse didn’t jump over the fence.’
- b. Motun Smef-ka koyangi-lul sa-ci ani ha-yess-ta.
 every Smurf-NOM cat-ACC buy-CI NEG do-PST-DECL
 ‘Every Smurf didn’t buy a cat.’
- c. Motun yeca ai-ka toliki-lul tha-ci ani ha-yess-ta.
 every female kid-NOM merry-go-round-ACC ride-CI NEG do-PST-DECL
 ‘Every girl didn’t ride on the merry-go-round.’
- d. Motun namca-ka konglyong-ul manci-ci ani ha-yess-ta.
 every man-NOM dinosaur-ACC pet-CI NEG do-PST-DECL
 ‘Every man didn’t pet the dinosaur.’
- (64) *Object QP – short neg – neg > V; object QP – short neg – V > neg*
- a. Kuphi-ka motun panci-lul an sa-ss-ta.
 Goofy-NOM every ring-ACC NEG buy-PST-DECL
 ‘Goofy didn’t buy every ring.’
- b. Khwukhi Monste-ka motun khwukhi-lul an mek-ess-ta.
 Cookie Monster-NOM every cookie-ACC NEG eat-PST-DECL
 ‘Cookie Monster didn’t eat every cookie.’
- c. Swuntoli-ka motun catongcha-lul an ssis-ess-ta.
 Swuntoli-NOM every car-ACC NEG wash-PST-DECL
 ‘Swuntoli didn’t wash every car.’
- d. Ttungpo-ka motun khokkili-lul thakca wi-ey an olli-ess-ta.
 fat.man-NOM every elephant-ACC table top-at NEG put-PST-DECL
 ‘The fat man didn’t put every elephant on the table.’
- (65) *Object QP – long neg – neg > V; object QP – long neg – V > neg*
- a. Kuphi-ka motun panci-lul sa-ci ani ha-yess-ta.
 Goofy-NOM every ring-ACC buy-CI NEG do-PST-DECL
 ‘Goofy didn’t buy every ring.’

- b. Khwukhi Monste-ka motun khwukhi-lul mek-ci ani ha-yess-ta.
 Cookie Monster-NOM every cookie-ACC eat-CI NEG do-PST-DECL
 ‘Cookie Monster didn’t eat every cookie.’
- c. Swuntoli-ka motun catongcha-lul ssi-ci ani ha-yess-ta.
 Swuntoli-NOM every car-ACC wash-CI NEG do-PST-DECL
 ‘Swuntoli didn’t wash every car.’
- d. Ttungpo-ka motun khokkili-lul thakca wi-ey olli-ci ani ha-yess-ta.
 fat.man-NOM every elephant-ACC table top-at put-CI NEG do-PST-DECL
 ‘The fat man didn’t put every elephant on the table.’

Appendix B: Fillers

This appendix provides the filler sentences we used in each condition.

(66) *Fillers for subject QP – short neg – neg > V*

- a. Khokkili-ka namwu wi-ey ollaka-ci ani ha-yess-ta.
 elephant-NOM wood top-at climb-CI NEG do-PST-DECL
 ‘The elephant didn’t climb up the tree.’
- b. Kuphi-ka panci-lul phal-ci ani ha-yess-ta.
 Goofy-NOM ring-ACC sell-CI NEG do-PST-DECL
 ‘Goofy didn’t sell the ring.’
- c. Himsseyn cangsa-ka motun phantteyki-lul kkay-ss-ta.
 strong man-NOM every wood-ACC break-PST-DECL
 ‘The strong man broke every piece of wood.’
- d. Smef-ka motun ppang-ul mek-ess-ta.
 Smurf-NOM every bread-ACC eat-PST-DECL
 ‘The Smurf ate every loaf of bread.’

(67) *Fillers for subject QP – short neg – V > neg*

- a. Wonswungi-ka namwu wi-ey ollaka-ci ani ha-yess-ta.
 monkey-NOM wood top-at climb-CI NEG do-PST-DECL
 ‘The monkey didn’t climb up the tree.’
- b. Himsseyn cangsa-ka motun pyektol-ul kkay-ss-ta.
 strong man-NOM every brick-ACC break-PST-DECL
 ‘The strong man broke every brick.’
- c. Ttungpo-ka kewul-ul phal-ci ani ha-yess-ta.
 fat.man-NOM mirror-ACC sell-CI NEG do-PST-DECL
 ‘The fat man didn’t sell the mirror.’
- d. Smef-ka motun khwukhi-lul mek-ess-ta.
 Smurf-NOM every cookie-ACC eat-PST-DECL
 ‘The Smurf ate every cookie.’

- (68) *Fillers for subject QP – long neg – neg > V; subject QP – long neg – V > neg*
- a. Wonswungi-ka namwu wi-ey an ollaka-ss-ta.
 monkey-NOM wood top-at NEG climb-PST-DECL
 ‘The monkey didn’t climb up the tree.’
 - b. Himsseyn cangsa-ka motun pyektol-ul kkay-ss-ta.
 strong man-NOM every brick-ACC break-PST-DECL
 ‘The strong man broke every brick.’
 - c. Tungpo-ka kewul-ul an phal-ass-ta.
 fat.man-NOM mirror-ACC NEG sell-PST-DECL
 ‘The fat man didn’t sell the mirror.’
 - d. Smef-ka motun khwukhi-lul mek-ess-ta.
 Smurf-NOM every cookie-ACC eat-PST-DECL
 ‘The Smurf ate every cookie.’
- (69) *Fillers for object QP – short neg – neg > V*
- a. Khokkili-ka namwu wi-ey ollaka-ci ani ha-yess-ta.
 elephant-NOM wood top-at climb-CI NEG do-PST-DECL
 ‘The elephant didn’t climb up the tree.’
 - b. Kuphi-ka panci-lul phal-ci ani ha-yess-ta.
 Goofy-NOM ring-ACC sell-CI NEG do-PST-DECL
 ‘Goofy didn’t sell the ring.’
 - c. Motun namca-ka phantteyki-lul kkay-ss-ta.
 every man-NOM wood-ACC break-PST-DECL
 ‘Every man broke a piece of wood.’
 - d. Motun konglyong-i namwu-eyse tteleci-ess-ta.
 every dinosaur-NOM tree-from fall-PST-DECL
 ‘Every dinosaur fell from the tree.’
- (70) *Fillers for object QP – short neg – V > neg*
- a. Wonswungi-ka namwu wi-ey ollaka-ci ani ha-yess-ta.
 monkey-NOM wood top-at climb-CI NEG do-PST-DECL
 ‘The monkey didn’t climb the tree.’
 - b. Tungpo-ka kewul-ul phal-ci ani ha-yess-ta.
 fat.man-NOM mirror-ACC sell-CI NEG do-PST-DECL
 ‘The fat man didn’t sell the mirror.’
 - c. Motun namca-ka pyektol-ul kkay-ss-ta.
 every man-NOM brick-ACC break-PST-DECL
 ‘Every man broke a brick.’
 - d. Motun pelley-ka namwu-eyse tteleci-ess-ta.
 every bug-NOM tree-from fall-PST-DECL
 ‘Every bug fell from the tree.’

- (71) *Fillers for object QP – long neg – neg > V; object QP – long neg – V > neg*
- a. Wonswungi-ka namwu wi-ey an ollaka-ss-ta.
 monkey-NOM wood top-at NEG climb-PST-DECL
 ‘The monkey didn’t climb the tree.’
 - b. Ttungpo-ka kewul-ul an phal-ass-ta.
 fat.man-NOM mirror-ACC NEG sell-PST-DECL
 ‘The fat man didn’t sell the mirror.’
 - c. Motun namca-ka pyektol-ul kkay-ss-ta.
 every man-NOM brick-ACC break-PST-DECL
 ‘Every man broke a brick.’
 - d. Motun pelley-ka namwu-eyse tteleci-ess-ta.
 every bug-NOM tree-from fall-PST-DECL
 ‘Every bug fell from the tree.’

References

- Ahn, Sung-Ho. 1990. Korean quantification and Universal Grammar. Doctoral dissertation, University of Connecticut, Storrs.
- Amritavalli, R. 1998. Kannada clause structure. Paper presented at the GLOW Colloquium, Hyderabad.
- Aronoff, Mark, and S. N. Sridhar. 1983. Morphological levels in English and Kannada: Atarizing Reagan. In *Papers from the Parasession on Interplay of Phonology, Morphology, and Syntax*, ed. by John F. Richardson, Mitchell Marks, and Amy Chukerman, 3–16. Chicago: University of Chicago, Chicago Linguistic Society.
- Baek, Judy Yoo-Kyung. 1998. Negation and object shift in early child Korean. In *The interpretive tract*, ed. by Uli Sauerland and Orin Percus, 73–86. MIT Working Papers in Linguistics 25. Cambridge, Mass.: MIT, Department of Linguistics and Philosophy, MITWPL.
- Bobaljik, Jonathan David, and Dianne Jonas. 1996. Subject positions and the roles of TP. *Linguistic Inquiry* 27:195–236.
- Cho, Choon-Hak. 1975. The scope of negation in Korean. In *The Korean language: Its structure and social projection*, ed. by Ho-Min Sohn, 121–132. Honolulu: University of Hawaii, Center for Korean Studies.
- Cho, Dong-In. 1994. Functional projections and verb movement. In *Theoretical issues in Korean linguistics*, ed. by Young-Key Kim-Renaud, 233–254. Stanford, Calif.: CSLI Publications.
- Cho, Young-Mee Yu, and Ki-Sun Hong. 1988. Evidence for the VP constituent from child Korean. In *Papers and reports on child language development* 27, 31–38. Stanford, Calif.: Stanford University, Department of Linguistics.
- Choe, Hyon Sook. 1988. Restructuring parameters and complex predicates: A transformational approach. Doctoral dissertation, MIT, Cambridge, Mass.
- Choi, Young-Sik. 1999. Negation, its scope and NPI licensing in Korean. In *ESCOL '99*, ed. by Rebecca Daly and Anastasia Riehl, 25–36. Ithaca, N.Y.: Cornell University, CLC Publications.
- Chomsky, Noam. 1965. *Aspects of the theory of syntax*. Cambridge, Mass.: MIT Press.
- Chomsky, Noam. 1981. *Lectures on government and binding*. Dordrecht: Foris.
- Chomsky, Noam. 1986. *Barriers*. Cambridge, Mass.: MIT Press.
- Chung, Daeho. 2004. A multiple dominance analysis of right node sharing constructions. *Language Research* 40:791–811.

- Chung, Daeho, and Hong-Keun Park. 1997. NPIs outside of negation scope. In *Japanese/Korean linguistics 6*, ed. by Ho-Min Sohn and John Haig, 415–435. Stanford, Calif.: CSLI Publications.
- Cinque, Guglielmo. 1999. *Adverbs and functional heads: A cross-linguistic perspective*. Oxford: Oxford University Press.
- Crain, Stephen, and Cecile McKee. 1986. The acquisition of structural restrictions on anaphora. In *Proceedings of NELS 16*, ed. by Stephen Berman, Jae-Woong Choe, and Joyce McDonough, 94–110. Amherst: University of Massachusetts, GLSA.
- Crain, Stephen, and Rosalind Thornton. 1998. *Investigations into Universal Grammar: A guide to research in acquisition of syntax and semantics*. Cambridge, Mass.: MIT Press.
- Emonds, Joseph. 1978. The verbal complex V'-V in French. *Linguistic Inquiry* 9:151–175.
- Fukui, Naoki. 1986. A theory of category projection and its applications. Doctoral dissertation, MIT, Cambridge, Mass.
- Fukui, Naoki, and Hiromu Sakai. 2003. The visibility guideline for functional categories: Verb-raising in Japanese and related issues. *Lingua* 113:321–375.
- Hagstrom, Paul. 2000. Phrasal movement in Korean negation. In *Proceedings of the 9th Student Conference in Linguistics (SCIL 9)*, ed. by Ljuba Veselinova, Susan Robinson, and Lamont Antieau, 127–142. MIT Working Papers in Linguistics 36. Cambridge, Mass.: MIT, Department of Linguistics and Philosophy, MITWPL.
- Hagstrom, Paul. 2002. Implications of child error for the syntax of negation in Korean. *Journal of East Asian Linguistics* 11:211–242.
- Hahn, Kyung-Ja Park. 1981. The development of negation in one Korean child. Doctoral dissertation, University of Hawaii, Honolulu.
- Han, Ho, and Myung-Kwan Park. 1994. The syntax of negation in Korean and its development in child language. In *ESCOL '94*, ed. by Janet Fuller, Ho Han, and David Parkinson, 152–162. Ithaca, N.Y.: Cornell University, CLC Publications.
- Heycock, Caroline, and Young-Suk Lee. 1989. Subjects and predication in Korean and Japanese. In *Japanese/Korean linguistics 2*, ed. by Hajime Hoji, 239–254. Stanford, Calif.: CSLI Publications.
- Hoji, Hajime. 1998. Null object and sloppy identity in Japanese. *Linguistic Inquiry* 29:127–152.
- Joo, Yanghee. 1989. A cross-linguistic approach to quantification in syntax. Doctoral dissertation, University of Wisconsin, Madison.
- Kim, Jong-Bok. 1995. On the existence of NegP in Korean. In *Harvard studies in Korean linguistics 6*, ed. by Susumu Kuno et al., 267–282. Cambridge, Mass.: Harvard University, Department of Linguistics.
- Kim, Jong-Bok. 2000a. *The grammar of negation: A constraint-based approach*. Stanford, Calif.: Stanford University.
- Kim, Jong-Bok. 2000b. On the prefixhood and scope of short form negation. In *Harvard studies in Korean linguistics 8*, ed. by Susumu Kuno et al., 403–418. Cambridge, Mass.: Harvard University, Department of Linguistics.
- Kim, Soowon. 1999. Sloppy/Strict identity, empty objects, and NP ellipsis. *Journal of East Asian Linguistics* 8:255–284.
- Kim, Young-Joo. 1997. The acquisition of Korean. In *The crosslinguistic study of language acquisition*, vol. 4, ed. by Dan I. Slobin, 335–443. Hillsdale, N.J.: Lawrence Erlbaum.
- Koizumi, Masatoshi. 2000. String vacuous overt verb-raising. *Journal of East Asian Linguistics* 9:227–285.
- Kroch, Anthony. 1989. Reflexes of grammar in patterns of language change. *Language Variation and Change* 1:199–244.
- Kuroda, S.-Y. 1988. Whether we agree or not: A comparative syntax of English and Japanese. *Linguisticæ Investigationes* 12:1–47.

- Lidz, Jeffrey. 1999. The morphosemantics of object case in Kannada. In *WCCFL 18*, ed. by Sonya Bird, Andrew Carnie, Jason D. Haugen, and Peter Norquest, 325–336. Somerville, Mass.: Cascadilla Press.
- Lidz, Jeffrey. 2006. The grammar of accusative case in Kannada. *Language* 82:1–23.
- Lidz, Jeffrey, and Julien Musolino. 2002. Children's command of quantification. *Cognition* 84:113–154.
- McMahon, Erin Leddon, Jeffrey Lidz, and Janet Pierrehumbert. 2004. Suprasegmental cues to meaning in child-directed speech. Paper presented at the 17th CUNY Sentence Processing Conference.
- Musolino, Julien, Stephen Crain, and Rosalind Thornton. 2000. Navigating negative quantificational space. *Linguistics* 38:1–32.
- No, Yong-Kyoon. 1988. Negative morphemes in Korean. In *Proceedings of the 6th International Circle of Korean Linguistics*, ed. by Eung-Jin Baek, 556–567. Seoul: Hanshin.
- Otani, Kazuyo, and John Whitman. 1991. V-raising and VP-ellipsis. *Linguistic Inquiry* 22:345–358.
- Papafraçou, Anna, and Julien Musolino. 2003. Scalar implicatures: Experiments at the semantics-pragmatics interface. *Cognition* 86:253–282.
- Park, Hee-Heon. 1998. Acquisition of negation in Korean. *Korean Linguistics* 9:111–131.
- Park, Kabyoung. 1992. Light verb constructions in Korean and Japanese. Doctoral dissertation, University of North Carolina, Chapel Hill.
- Park, Myung-Kwan. 1998. Negation and the placement of verb in Korean. *Language Research* 34:709–736.
- Pintzuk, Susan. 1991. Phrase structures in competition: Variation and change in Old English word order. Doctoral dissertation, University of Pennsylvania, Philadelphia.
- Pollock, Jean-Yves. 1989. Verb movement, Universal Grammar, and the structure of IP. *Linguistic Inquiry* 20:365–424.
- Reinhart, Tanya. 1997. Quantifier scope: How labor is divided between QR and choice functions. *Linguistics and Philosophy* 20:335–397.
- Roeper, Thomas. 1999. Universal bilingualism. *Bilingualism: Language and Cognition* 2:169–186.
- Roeper, Thomas. 2002. Multiple grammars, feature-attraction, pied-piping, and the question: Is AGR inside TP? Ms., University of Massachusetts, Amherst.
- Saito, Mamoru. 1985. Some asymmetries in Japanese and their theoretical implications. Doctoral dissertation, MIT, Cambridge, Mass.
- Saito, Mamoru. 1997. Syntactic chains and quantifier scope. Forum lecture presented at the Linguistic Society of America Linguistic Institute, Cornell University.
- Santorini, Beatrice. 1992. Variation and change in Yiddish subordinate clause word order. *Natural Language and Linguistic Theory* 10:596–640.
- Sohn, Keun-Won. 1995. Negative polarity items, scope and economy. Doctoral dissertation, University of Connecticut, Storrs.
- Song, Seok Choong. 1982. On interpreting the scope of negation in Korean. *Language Research* 18:197–215.
- Suh, Jin-Hee. 1989. Scope interaction in negation. In *Harvard studies in Korean linguistics* 3, ed. by Susumu Kuno et al., 527–536. Cambridge, Mass.: Harvard University, Department of Linguistics.
- Taylor, Ann. 1994. The change from SOV to SVO in Ancient Greek. *Language Variation and Change* 6: 1–37.
- Yang, Charles. 2000. Knowledge and learning in natural language. Doctoral dissertation, MIT, Cambridge, Mass.
- Yi, Eun-Young. 1994. NegP in Korean. In *Papers on negation*, ed. by Howard Grabois, David Parkinson, and Deborah Yeager, 193–208. Cornell Working Papers in Linguistics 12. Ithaca, N.Y.: Cornell University, CLC Publications.
- Yoon, James Hye-Suk. 1994. Korean verbal inflection and checking theory. In *The morphology-syntax connection*, ed. by Heidi Harley and Colin Phillips, 251–270. MIT Working Papers in Linguistics 22. Cambridge, Mass.: MIT, Department of Linguistics and Philosophy, MITWPL.

(Han)

*Department of Linguistics
Simon Fraser University
8888 University Drive
Burnaby, British Columbia V5A1S6
Canada*

chungnye@sfu.ca

(Lidz)

*Department of Linguistics
University of Maryland
1401 Marie Mount Hall
College Park, Maryland 20742*

jlidz@umd.edu

(Musolino)

*Department of Speech and Hearing Sciences
Indiana University
200 S. Jordan Avenue
Bloomington, Indiana 47405-7002*

musolino@indiana.edu